

Aluminum Folding Systems

Introduction

Systems and Common Features	3
Comparison of Different Aluminum Systems	5
Suggested Selection Procedure	6
Standard Configurations	7
Unhinged Paired Panels	13
Fold Flat	14
Open Corner with 90° and 135° Angle Turns	16
Center Pivot	17
Segmented Curve Units	18
Some Panels Inward, Some Outward	19
Folding Door / Window Combination in One Unit	20

NanaWall SL60 - Standard Thermally Broken Aluminum Folding System

Features	1
Technical Description	2
Performance and Testing Results	4
Maximum Frame Size Chart	16
Relationship of Frame, Panel and Glass Sizes	18
Inward Opening Section Details	19
Outward Opening Section Details	25
Suggested Typical Installation	31
Other Section Drawings	36
Design Windload Charts	37
Specifications Guide	39

NanaWall SL45 - Monumental Folding/Paired Panel Aluminum Folding System

Features	1
Technical Description	2
Performance and Testing Results	4
Maximum Frame Size Chart	10
Relationship of Frame, Panel and Glass Sizes	11
Inward Opening Section Details	12
Outward Opening Section Details	15
Suggested Typical Installation	18
Other Section Details	20
Design Windload Chart	21
Specifications Guide	23

NanaWall SL70 - Monumental Thermally Broken Aluminum Folding System

Features	1
Technical Description	3
Performance and Testing Results	5

Maximum Frame Size Chart	13
Relationship of Frame, Panel and Glass Sizes	14
Inward Opening Section Details	15
Outward Opening Section Details	20
Suggested Typical Installations	25
Other Section Details	29
Design Windload Charts	30
Specifications Guide	35
NanaWall SL73 - Miami Dade / AAMA Hurricane Thermally Broken Aluminum Folding System	
Features	1
Technical Description	2
Performance and Testing Results	5
Maximum Frame Size Chart	9
Relationship of Frame, Panel and Glass Sizes	10
Inward Opening Section Details	11
Outward Opening Section Details	16
Suggested Typical Installation	21
Other Section Details	25
Design Windload Charts	26
Specifications Guide	29
NanaWall SL80 - The Narrow Stiles, Thermally Broken, Aluminum Framed Folding System with Superior Thermal Performance	
Features	1
Technical Description	2
Performance and Testing Results	3
Maximum Frame Size Chart	11
Relationship of Frame, Panel and Glass Sizes	12
Inward Opening Section Details	13
Outward Opening Section Details	19
Other Section Details	25
Suggested Typical Installation	26
Design Windload Charts	29
Specifications Guide	31
NanaWall SL82 - Structurally Glazed Thermally Broken Aluminum Folding System	
Features	1
Performance and Testing Results	4
Maximum Frame Size Chart	6
Relationship of Frame, Panel and Glass Sizes	7
Inward Opening Section Details	8
Design Windload Charts	12
Specifications Guide	15

Aluminum Framed Folding NanaWall Systems That Make Large Exterior Openings Possible

Six Different Aluminum Framed Folding Panel Systems and a Paired Panel System are Available

NanaWall Systems, Inc. offers six different aluminum framed folding door systems:

SL60 -The Standard Thermally Broken Folding System

SL45 -The Monumental Folding/Paired-Panel System

SL70 -The Monumental Thermally Broken Hurricane Rated Folding System

SL73 - Miami Dade / AAMA Hurricane Thermally Broken Folding System

SL80/81 – The Narrow Stiles / Low u values Thermally Broken Folding System

SL82 - Structurally Glazed Thermally Broken Folding System

Large Exterior Openings Are Possible

With NanaWall folding systems, openings can range from as few as two panels to as many as twelve panels and can be as wide as 43' (13 m). With paired panels, virtually unlimited widths are possible.

Engineered, Tested Systems from a Single Source Supplier

NanaWalls have been engineered for superior performance. Some units have been independently tested for air and water penetration resistance, structural deflection, thermal performance and forced entry. The SL60, SL70 and SL73 are NFRC certified and labeled, and have also been tested for acoustic performance. The SL73 is Miami-Dade County / AAMA hurricane approved. All systems, except the SL80 and SL82, are state wide Florida approved.

Secure / Single Hand Operation

Multiple point locking that operates with a turn of a handle. The top and bottom shoots bolts between each folding pair of panels have a full 24 mm throw. Independent tests confirm that the locking system passes strict California forced entry testing requirements. No surface mounted flush bolts are used for standard units.

Versatile Functions

Versatile functions with swing entry/exit panel(s) option and with flexibility to fully or partially open. Ease of operation to quickly open or close wide openings.

Multitude of Stacking Configurations

Over fifty stacking configurations as well as inward opening, outward opening, or center pivoted options. Unhinged paired panels option for maximum stacking flexibility and larger opening walls. 90°, 135°, segmented or other angled units are available on some systems.

Outstanding Appearance

European styling and handsome, sleek lines allow glass areas to be maximized. All folding and locking hardware is integrated into the profiles for a clean look and for narrow stacking. No surface mounted hinges are used.

Continued, Long-Term Satisfactory Operation

Smooth sliding and folding operation, even when the bottom track has some dirt and sand in it. State-of-the-art hardware with ball bearing running carriages. On top hung systems, the main weight is carried by the head track. Variable interlocking of profiles minimizes expansion problems. Long term ease of operation with adjustment features.

Easy to Install, Complete System

Easy to install with complete, precision built systems and pre-fitted hardware.

Design Flexibility

Design freedom with custom sizes, thermally broken and non-thermal options, glazing choices, and monumental series for larger panels or heavier glass panes. Top hung or floor supported. Raised sill or flush sill options.

A large selection of muntin layouts is offered. Horizontal mullions, SDL muntins with spacer bars, solid panels, or other custom layouts are available.

Choice of Finishes

In addition to the choices from the NanaWall Powder Coating Finish Chart in the front part of this binder, the full range of RAL high gloss and matte powder coating are available. Anodized finishes are also available. A RAL color chart is available on request.

Hardware Options

A choice of different locking options are available depending on need. Different handle finishes are also available see “Hardware” in the General Introduction. Depending on the configuration selected, door closers can be incorporated and units can be prepared for panic devices provided by others. Custodial hardware is also available.

Complete, Coordinated Glass Walls

With the SL joining system, complete, coordinated glass walls can be provided with various folding doors and folding windows combinations, single track sliding panel system (HSW), matching French doors, transoms, side lites, and corner posts; see the Matching Windows & Doors, HSW60 NanaWall and the HSW45 NanaWall sections.

Screen Classic and Screen ONE

The Screen Classic, a series of collapsible pleated screen panels riding a single track, is available as an option.

The system can be installed within the opening or, with extended tracks, be hidden out of view when not in use. See the Screens section for more information.

The Screen ONE is a non-pleated screening option for single openings up to 18' (5485 mm) wide and double openings up to 36' (10,970 mm) wide.

Comparison of Different Aluminum Folding Systems

All six of the SL aluminum framed folding systems have been designed, engineered and manufactured to the highest standards. Each system, however, has its own special, unique features and may be more suitable for certain applications than others. Below is a comparison of systems and features. See the individual sections for further system details.

	SL45	SL60	SL70	SL73	SL80/81	SL82
Profile thickness	1 3/4" (45 mm)	2 3/8" (60 mm)	2 3/4" (70 mm)	2 3/4" (70 mm)	3 1/8" (80 mm)	3 1/8" (80 mm)
Maximum Panel sizes possible rank with #1 being largest	45/s - 2 45/d - 4	60/o - 3 60/u - 3	1	3	2	4
SEE MAXIMUM SIZE CHARTS						
Thermally broken	No	Yes	Yes	Yes	Yes	Yes
Weather resistance #1 being highest	3	1	1	1	1	1
Structural load deflection #1 being highest	5	3	2	1	3	3
Sound control #1 being highest	3	2	1	1	1	1
Swing door 500,000 cycle tested	Yes	Yes (with surface hinges)	Yes	No	No	No
Running carriage support	Top Hung	60/o - top hung 60/u - floor supported	floor supported	floor supported	floor supported	floor supported
Inward opening	Yes	Yes	Yes	Yes	Yes	Yes
Outward opening	Yes	Yes	Yes	Yes	Yes	No
Some panels inward & some outward opening	Yes	No	No	No	No	No
FoldFlat Option (stacking of panels outside the opening)	Yes	No	No	No	No	No
Center pivoted option	Yes	No	No	No	No	No
Possibility of unhinged panels paired	Yes	60/o - Yes (not recommended) 60/u - No	No	No	No	No
Feature for easy cleaning of balcony units	No	60/o - Yes 60/u - No	No	No	No	No
Possibility of different finishes on inside & outside	No	Yes	Yes	Yes	Yes	No
Possibility of 90° turn (panels meeting at corner)	Yes	Yes	Yes	No	No	No
Segmented angles between each folding pair (see limits of each system)	Yes	No	Yes	No	No	No
Option of lever handles on swing panel	Yes	Yes	Yes	Yes	Yes	Yes
Approximate price comparison of standard unit without glass if SL45 is 100	100	113	125	**	150	190
NFRC Certified and Labeled	Pending	Yes	Yes	Yes	Yes	No

** Supplied with impact glass only

s = single glazing

o = top hung system

u = floor mounted system

Suggested Selection Procedure

As there are several different aluminum folding door systems available from NanaWall Systems, Inc., each with its own special features, study the Comparison Page, the different features of each system, the specifications, the section drawings, the sizes and configurations available, etc. and choose a system most suitable for your particular project.

Steps in Selecting an Aluminum Folding System

1. Select a system and whether single, double or triple glazed.
2. Determine the frame width and height.
 - a. From the rough opening height measured from subfloor, subtract 1/2" - 1" to obtain the frame height (note that the shim space is determined by any code requirements or personal preference). Adjust height as required if the bottom of the frame is not on the same level as the sub floor, especially with a flush sill.
 - b. From the rough opening width, subtract 3/4" (suggested shim space of 3/8" on each side) to obtain the frame width.
3. From the appropriate line on the Maximum Size Chart for your chosen system, for your specific frame height and frame width, determine the minimum number of panels needed. Please note that any custom size is possible up to the maximum size line shown.
4. From the different configurations shown that are available for that number of panels, select a configuration. Configuration determination is made with viewing from the inside. Note the lower size restrictions if a configuration with a swing panel not attached to a side jamb is selected. ("B" line). If this is the case you may need to adjust your sizes, number of panels or configurations if you are not within the "B" line.
5. Select an inward or outward opening unit. The first letter in the model number indicates inward or outward opening. "I" is inward and "A" is outward. After the "I" or "A" in the model number, the number preceded by "L" indicates the number of panels folding to the left and the number preceded by "R" indicates the number of panels folding to the right. For example, 1L3R indicates 1 panel folding to left and 3 panels folding to right, while its mirror opposite 3L1R indicates 3 panels folding to the left and 1 panel folding to the right.
6. From the elevations and cross-sections, actual and nominal heights and widths of the individual panels can be determined. As panels overlap and some configurations include running astragals, panel sizes are not necessarily all equal and vary with each configuration. Panel height

also vary with the head jamb size and sill used. For each system, see Relationship of Frame, Panel and Glass Daylight Opening Sizes page.

7. Select a sill option.
8. Select the finish desired from the standard and optional colors available. For the SL60, SL70, SL73 and SL80 systems different finishes for the inside and outside are available.
9. Select the locking system for the main entry panel.
10. Select handle type and finish of handles and hinges/ corner connectors from standard colors available.
11. Select any other options desired such as:
 - a. Special features available for system such as segmented curves, FoldFlat, center pivoted, unhinged pairs of panels, units with 90° or 135° turns, etc. Note the restrictions on some of these options.
 - b. Higher bottom rail.
 - c. Simulated divided lites.
 - d. Matching doors and windows.
 - e. Transoms and sidelites.
 - f. Screens.

Example

The SL 60/o is to be used for an opening with rough dimensions of 8' in height and 10' 3/4" in width.

Frame height = $FH = 8' - 1" = 7'11"$ (using 1" shim space)

Frame width = $FW = 10' 3/4" - 3/4" = 10'$ (using 3/4" shim space)

Looking at the "A" line on the Maximum Size Chart for SL 60, for a frame height of 7'11", a unit with at least 4 panels is necessary.

(For a 3 panel system, the frame width will need to be reduced to about 9'9".)

From the configurations available with 4 panels, Model 1L3R is chosen. The size is within the "B" line size.

From information on elevations and cross-sections for Model 1L3R, the following determination can be made:

Nominal panel width =

$(FW - 5 9/16")/4 = (9' - 5 9/16")/4 = 25.6"$ or 2' 1 5/8"

Glass width is 2' 1 5/8" - 3 9/16" = 1' 10 1/16"

If the raised sill is used, Panel Height =

Frame Height - 5 1/2" = 7'10" - 5 1/2" = 7' 4 1/2"

Glass height is 7' 4 1/2" - 3 9/16" = 7' 15/16"

Standard Configurations for All Aluminum Folding Systems except the SL82

Elevation Drawings of Models with Majority of Panels Folding to Right (looking from inside)

Shown to the right of each elevation are horizontal cross-section schematics of the folding operation of the panels. Shown are schematics for both inward (“I”) and outward opening (“A”) units with the upper part being the outside and lower part being the inside as shown on **Model 2R** below. **For inward opening section details, look at details with “.0” suffix; for outward opening section details, look at details with “.1” suffix.**

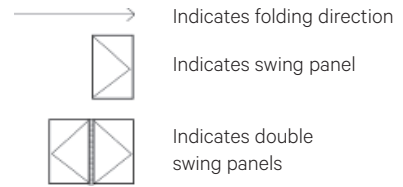

The SL82 is only available inward opening.

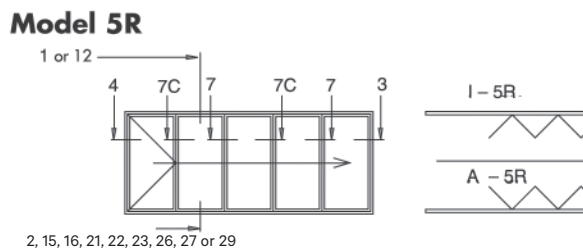
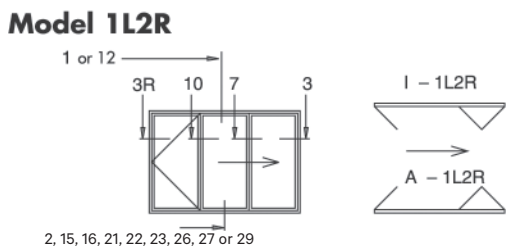
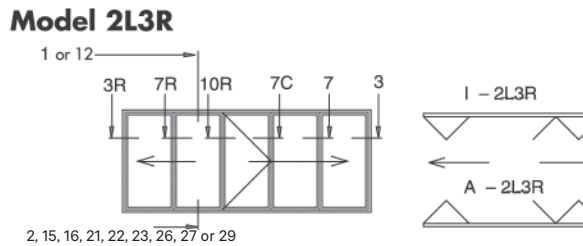
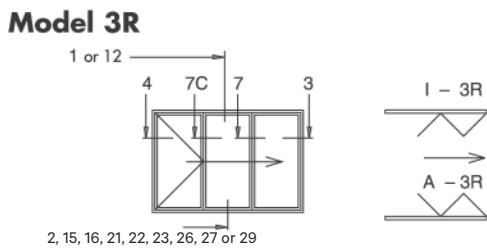
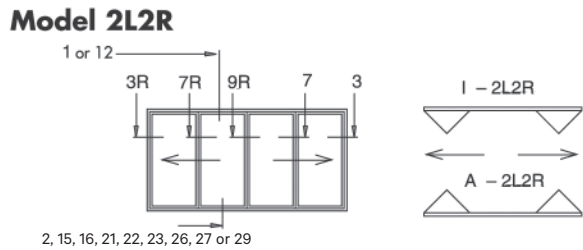
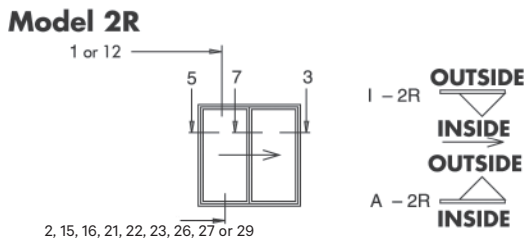
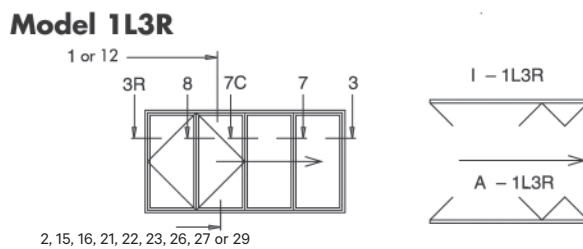
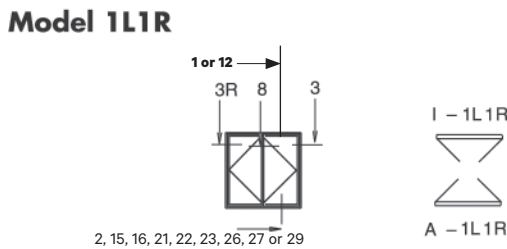
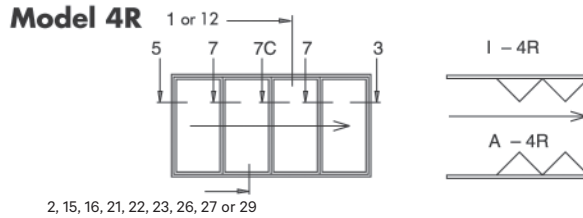
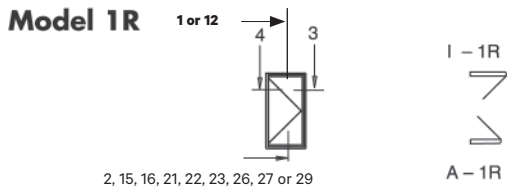

Standard Configurations for All Aluminum Folding Systems except the SL82

Elevation Drawings of Models with Majority of Panels Folding to Right (looking from inside)

The SL82 is only available inward opening.

Model 1L4R

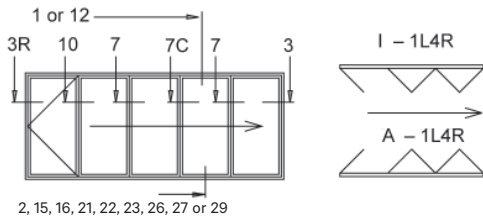

Model 1L6R

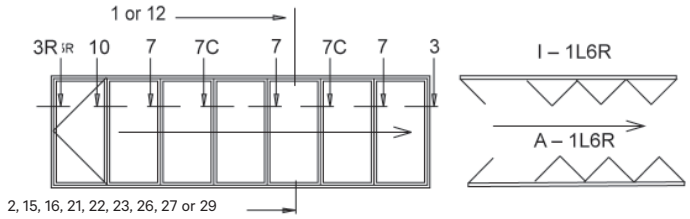

Model 3L3R

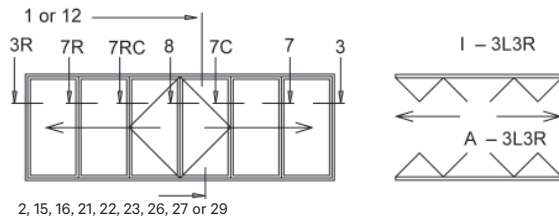

Model 2L5R

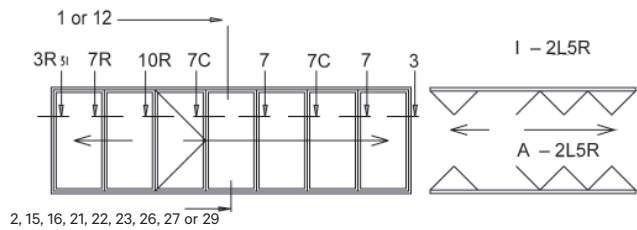

Model 1L5R

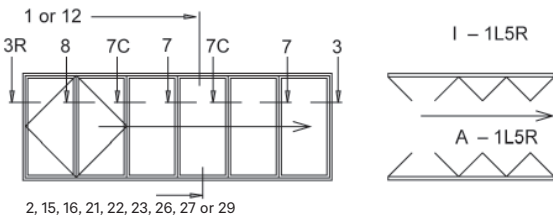

Model 3L4R

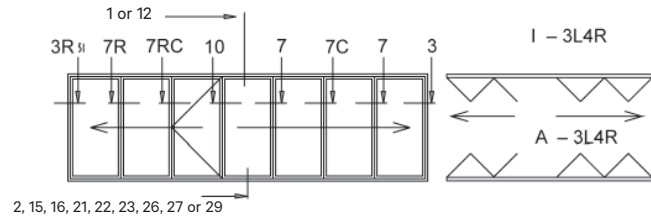

Model 2L4R

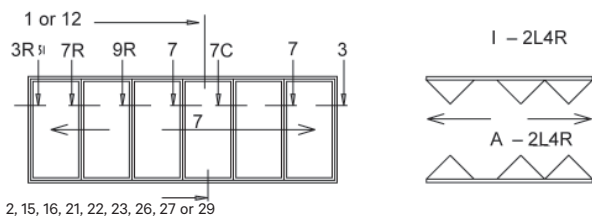

Model 4L4R

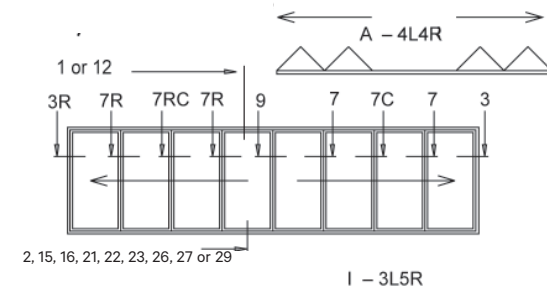

Model 6R

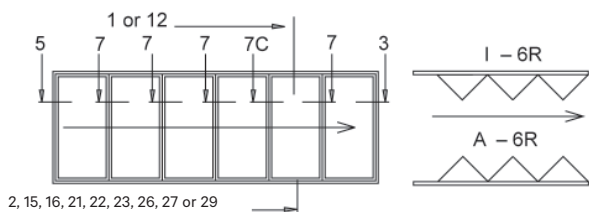

Model 3L5R

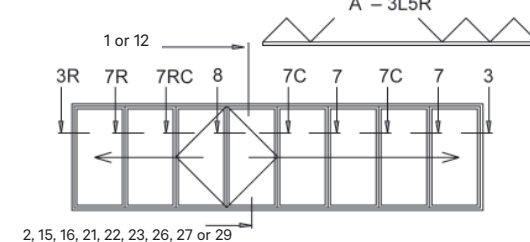

Standard Configurations for All Aluminum Folding Systems except the SL82

Elevation Drawings of Models with Majority of Panels Folding to Right (looking from inside)

The SL82 is only available inward opening.

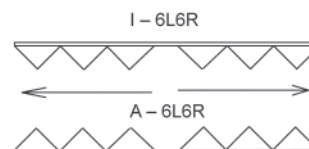
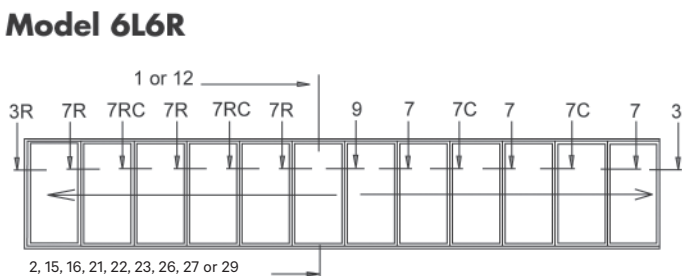
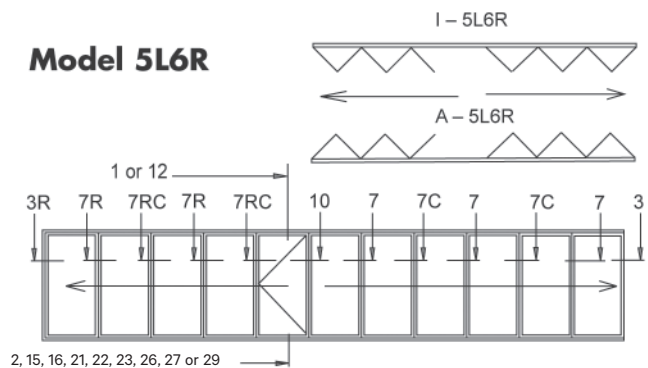
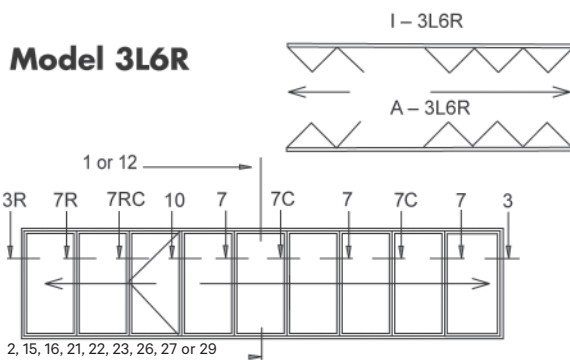
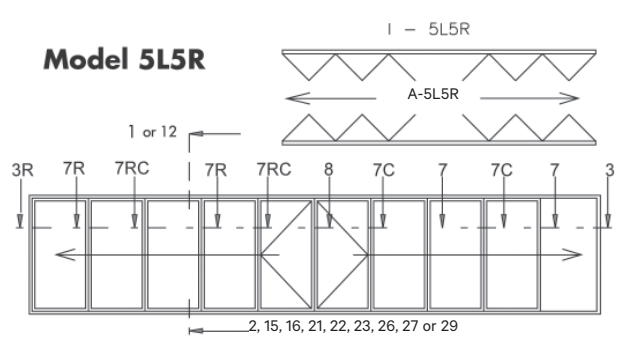
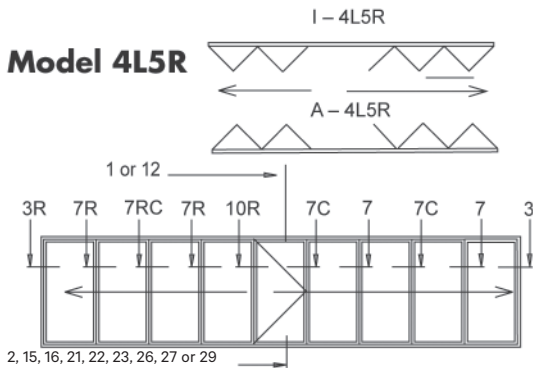
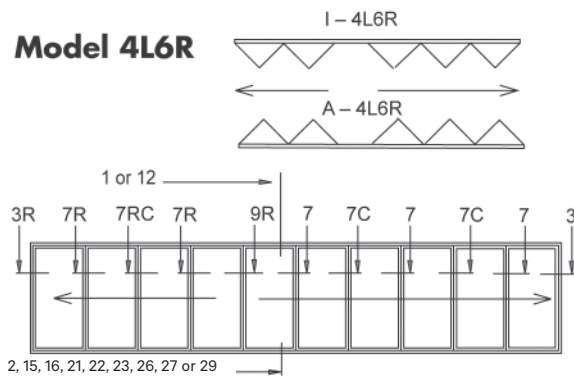
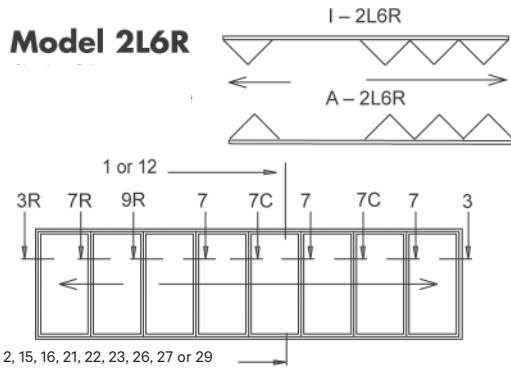

Standard Configurations for All Aluminum Folding Systems except the SL82

Elevation Drawings of Models with Majority of Panels Folding to Left (looking from inside)

Shown to the right of each elevation are horizontal cross-section schematics of the folding operation of the panels. The schematics are shown for both inward (“I”) and outward opening (“A”) units, with the upper part being the outside and the lower part being the inside, as shown on **Model 2L** below. **For inward opening section details, look at details with “0” suffix; for outward opening section details, look at details with “1” suffix.**

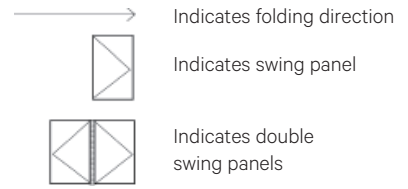

The SL82 is only available inward opening.

Model 1L

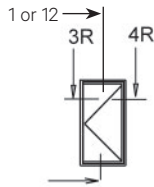

2, 15, 16, 21, 22, 23, 26, 27 or 29

Model 4L

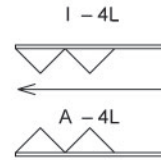
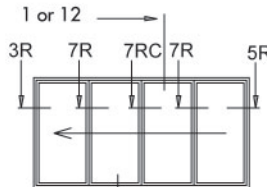

2, 15, 16, 21, 22, 23, 26, 27 or 29

Model 1L1R

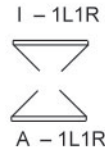
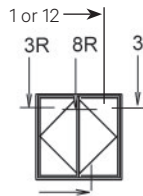

2, 15, 16, 21, 22, 23, 26, 27 or 29

Model 3L1R

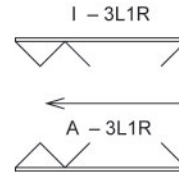
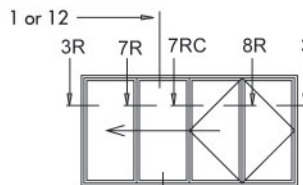

2, 15, 16, 21, 22, 23, 26, 27 or 29

Model 2L

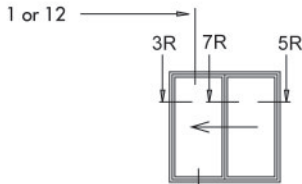

2, 15, 16, 21, 22, 23, 26, 27 or 29

Model 2L2R

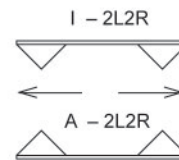
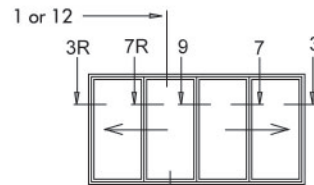

2, 15, 16, 21, 22, 23, 26, 27 or 29

Model 3L

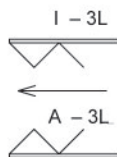
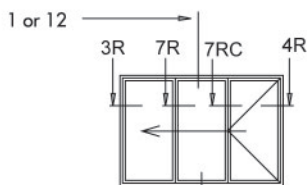

2, 15, 16, 21, 22, 23, 26, 27 or 29

Model 3L2R

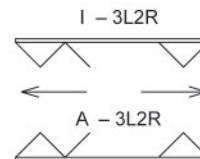
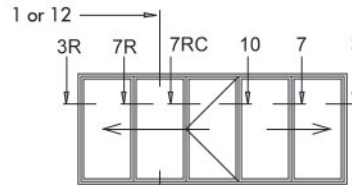

2, 15, 16, 21, 22, 23, 26, 27 or 29

Model 2L1R

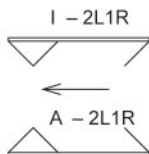
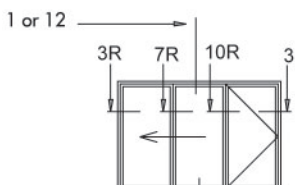

2, 15, 16, 21, 22, 23, 26, 27 or 29

Model 5L

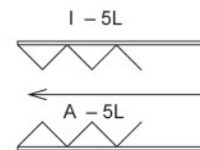
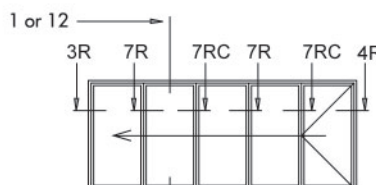

2, 15, 16, 21, 22, 23, 26, 27 or 29

Standard Configurations for All Aluminum Folding Systems except the SL82

Elevation Drawings of Models with Majority of Panels Folding to Left (looking from inside)

The SL82 is only available inward opening.

Model 4L1R

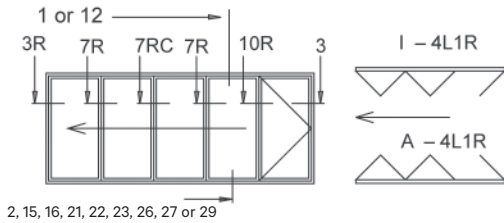

Model 6L1R

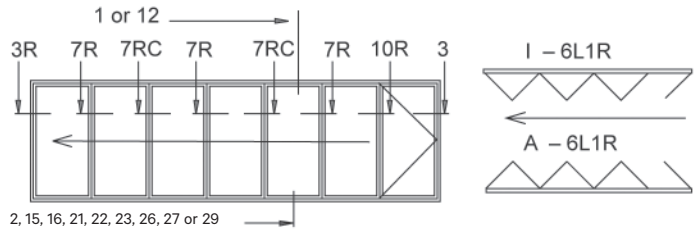

Model 3L3R

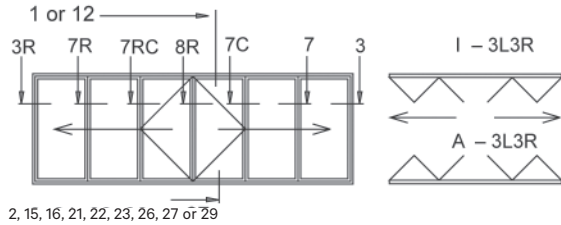

Model 5L2R

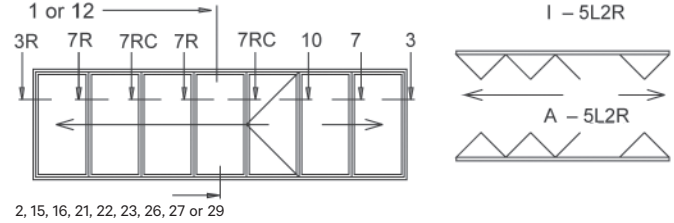

Model 5L1R

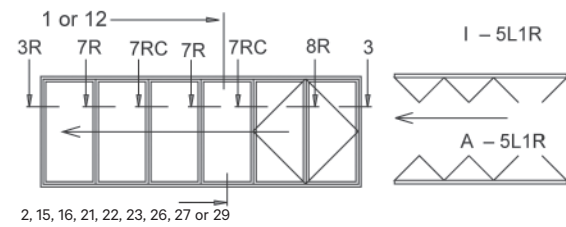

Model 4L3R

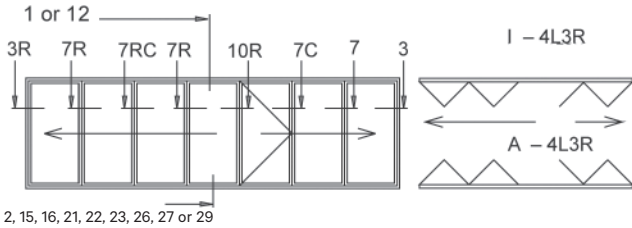

Model 4L2R

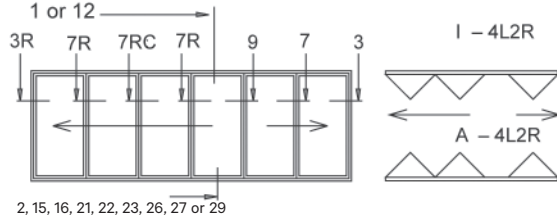

Model 4L4R

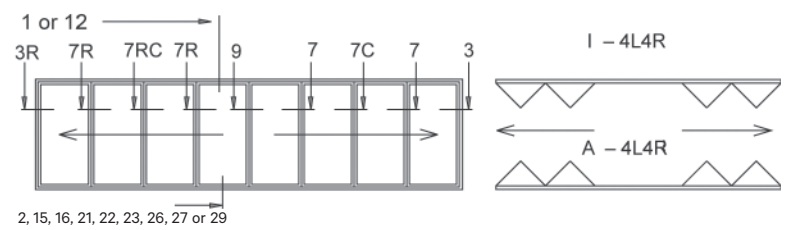

Model 6L

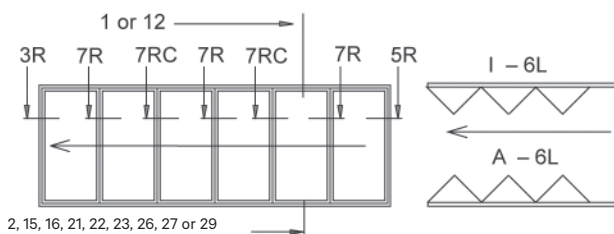

Model 5L3R

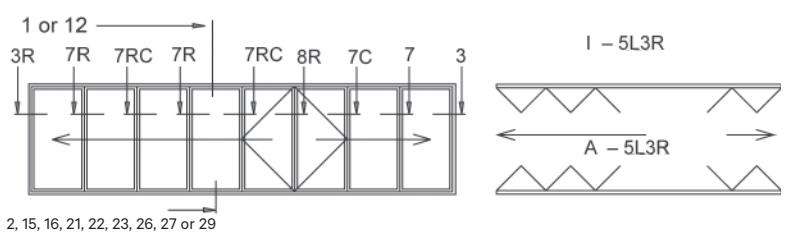

Standard Configurations for All Aluminum Folding Systems except the SL82

Elevation Drawings of Models with Majority of Panels Folding to Left (looking from inside)

The SL82 is only available inward opening.

Model 6L2R

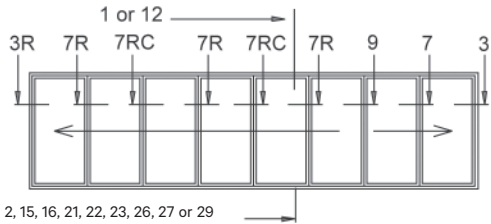
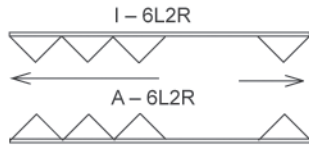

Model 6L4R

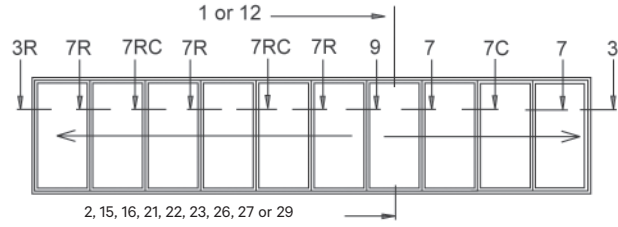
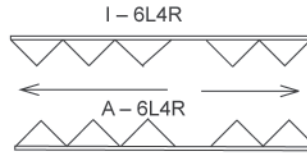

Model 5L4R

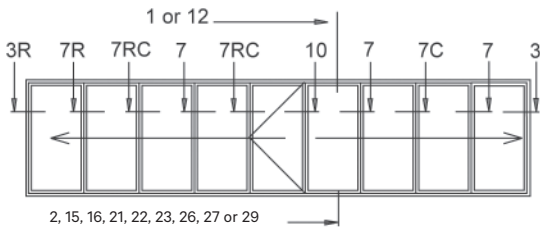
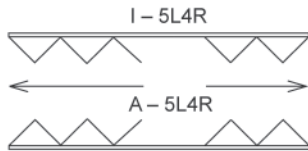

Model 5L5R

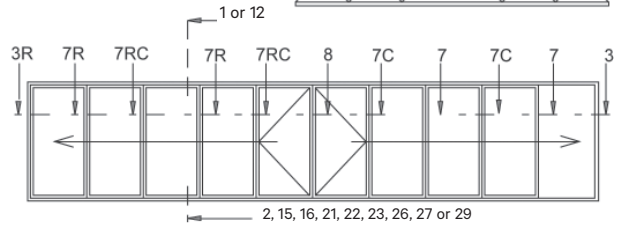
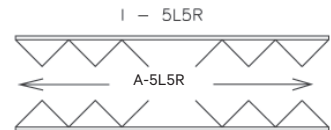

Model 6L3R

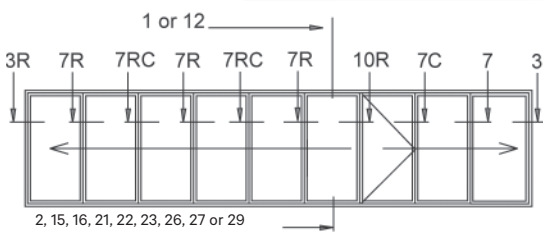
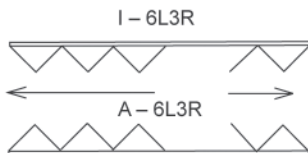

Model 6L5R

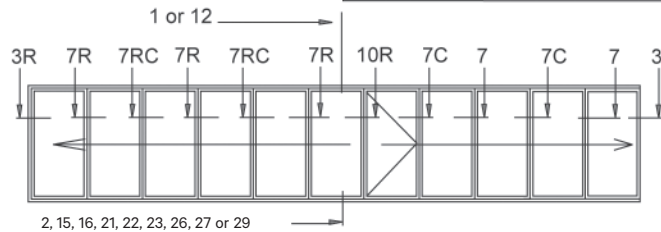
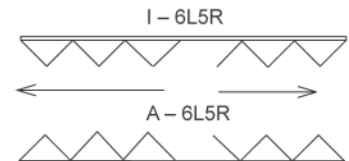

Model 6L6R

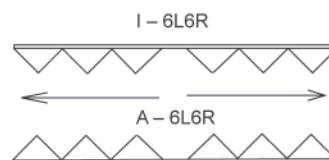
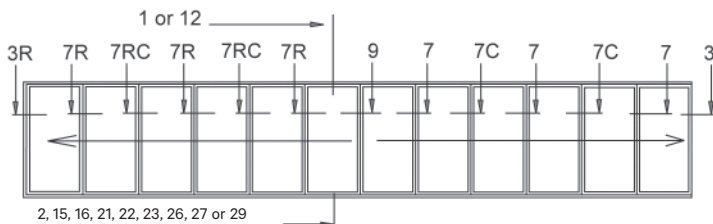

Stack Panels On Either Side with Unhinged Paired Panels:

Additional Possibilities with SL45

In configurations with an even number of panels on one or both sides, pairs of panels need not be hinged to a side jamb or other panels. Flexibility in folding in any direction or position along the track can be achieved by having sets of running carriages at **both** outside corners of a pair of panels or multiple of pairs of panels. Unhinged paired panels can be combined with hinged configurations for even more options. **Below are examples of some possibilities with inward opening units. See Center Pivot Option pages for additional possibilities.**

Please note that surface mounted bolts are needed in addition to the concealed locking.

Examples: As there can be many other possibilities, please submit your ideas and sketches to NanaWall Systems, Inc. for evaluation.

Model I-2LR

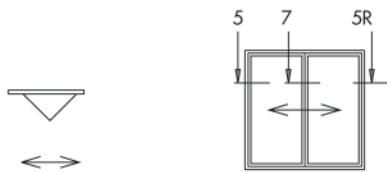

Model I-2LR 2LR

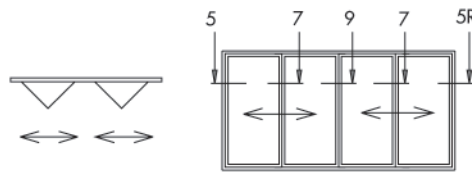

Model I-1L2LR

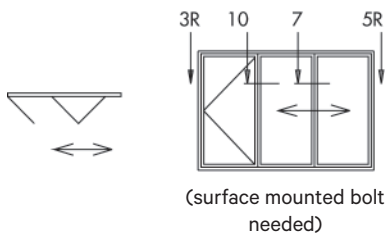

Model I-4LRO

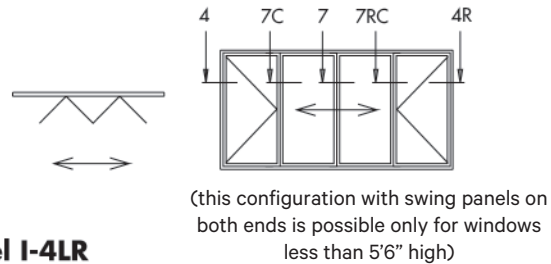

Model I-4LR

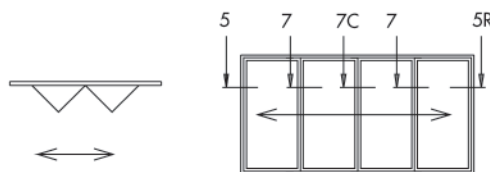

Model I-1L4LR1R

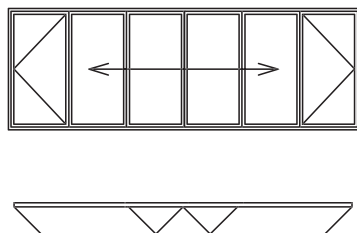

Model I-3L4LR

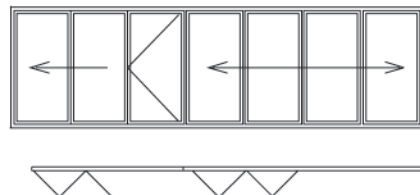

FoldFlat Against the Adjacent Wall:

Additional Possibilities with SL45

Now possible with configurations up to 3 panels on one side or 6 panels in an opening - creating a folding system that when opened, all panels are completely out of the opening with no separate structural support above needed.

For larger opening requirements, a FoldFlat on one side can be combined with a standard chain of bi-fold panels.

FoldFlat can be used as a door or window system.

FoldFlat is only available with the recessed flush sill (Detail 26) only.

Example of a FoldFlat unit - Inward Opening with 3 panels stacking flat against the adjacent wall.

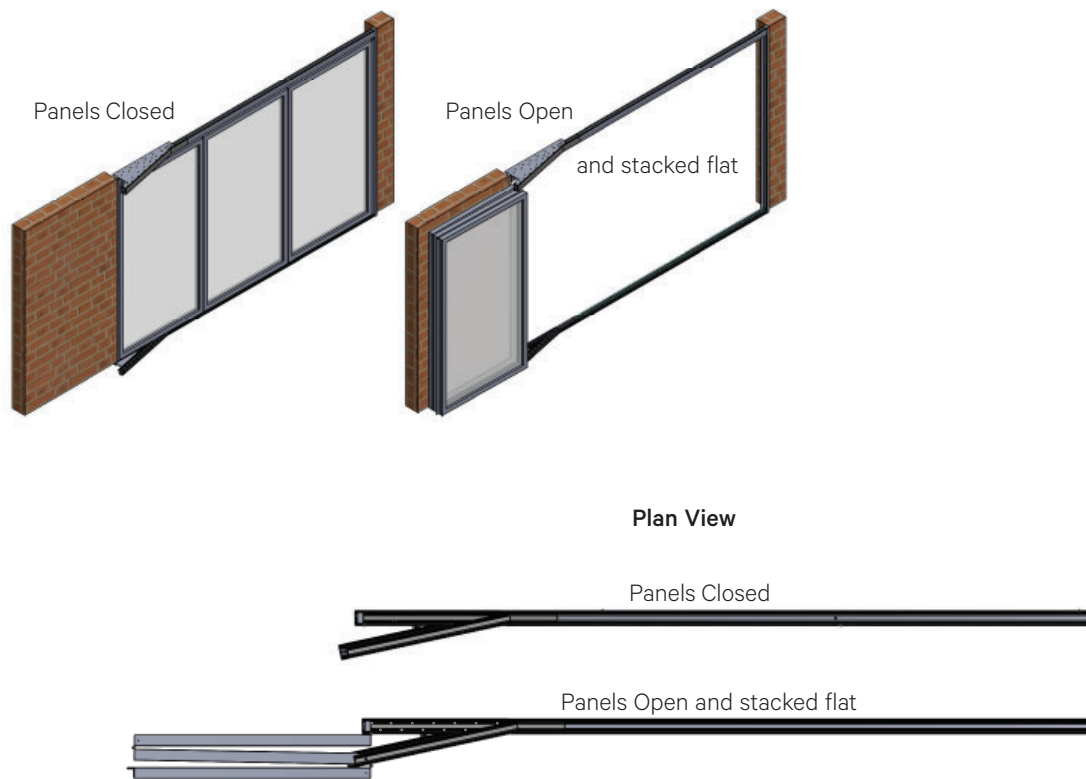

Some Installation Notes:

For panels to be able to FoldFlat against the adjacent wall, unit will need to be installed flush with the outermost projection of the adjacent wall. An alternate method of attaching the frame to the surrounding wall (instead of screwing through the center of the frame) will need to be used.

As shown in the drawings above, there will be an extension of the head track and sill outside the opening for the FoldFlat function. The head track extension will be self supporting. The sill extension will need to be recessed. In this sill extension area that is a max. of about 9" from the opening, there can be no changes in the floor level.

There should be adequate space on the adjacent wall to allow the panels to fold flat against the wall (at least the width of the widest panel).

FoldFlat Against the Adjacent Wall:

Additional Possibilities with SL45

Some Configurations Possible (Elevations are viewed from the inside.)

Configurations possible shown below are for outward opening units. The same can be achieved for inward opening units.

Model FFA - 2R

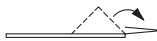
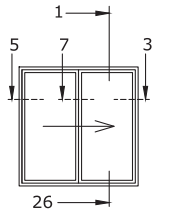

Model FFA - 2L

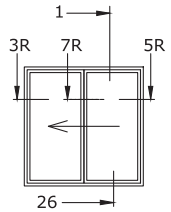

Model FFA - 1L2R

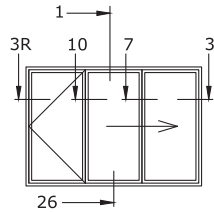

Model FFA - 2L1R

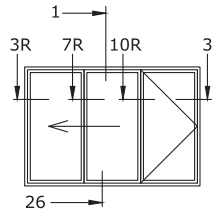

Model FFA - 3R

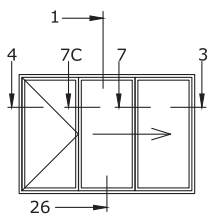

Model FFA - 3L

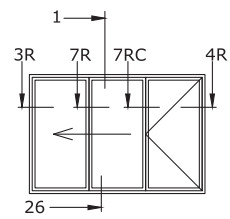

Model FFA - 1L3R

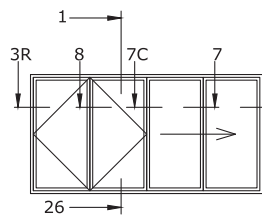

Model FFA - 3L1R

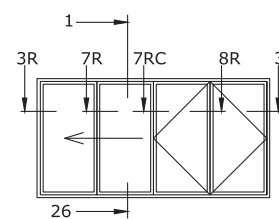

Model FFA - 2L2R

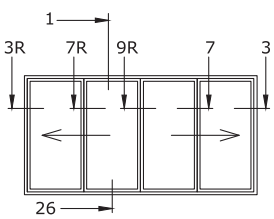

Model FFA - 2L3R

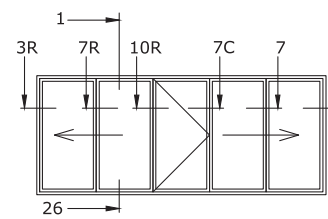

Model FFA - 3L2R

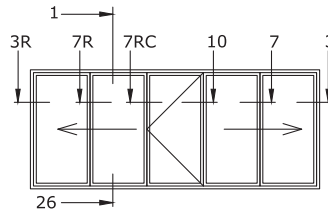

Model FFA - 3L3R

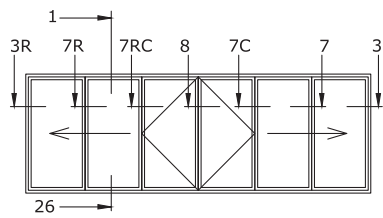

Other Configuration Possibilities

Instead of folding flat against the adjacent wall, the panels can fold flat against a fixed panel. For example, Model 1 Fixed + FFA - 3L

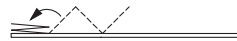
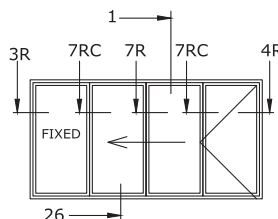

A Fold Flat Configuration on one side of the opening can also be combined with any of the other standard configurations on the other side of the opening. For example, FFA - 3L + A - 5R.

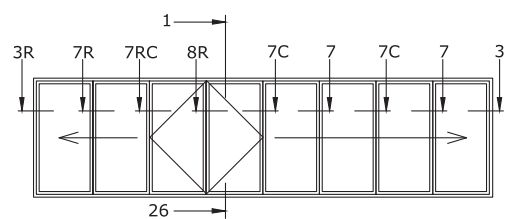

Open Corner with 90° Angle Turns:

Additional Possibilities with SL45, SL60, SL70 and SL80/81

(also 135° angle turn for SL45 and SL70)

For certain configurations of each of the systems – SL45, SL60 and SL70, a 90° angle (or 135°) turn of the head jamb and sill is possible. Create dramatic unique openings by opening two corners of a room without the need of a corner post. See below for some examples.

Please note that angled units are not as weather resistant as standard straight units.

Examples: As there can be many design possibilities, please submit your preliminary ideas and sketches to NanaWall Systems, Inc. for evaluation.

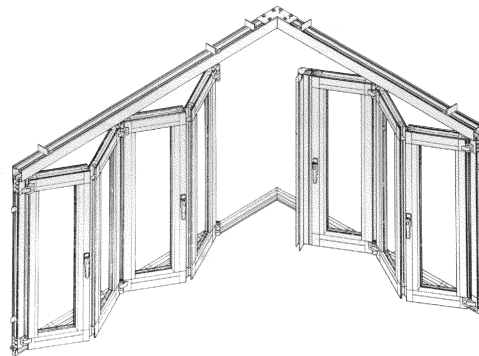

Inward Opening

I-1L+4R*



I-1L+3R*



I-2L+4R*

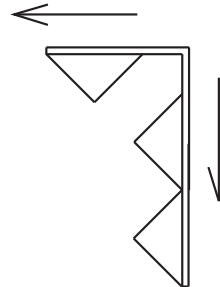

*Only possible with SL45

Outward Opening

A-1L+2R

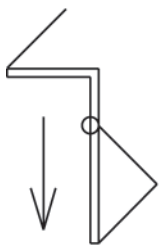

A-1L+3R



A-2L+2R

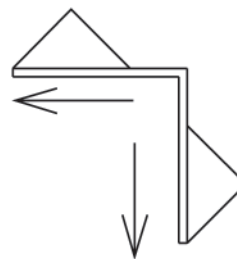

Shown are outside corner configurations. Inside corners are also possible.

Many other configurations are possible and are derived from these above basic configurations. They are created by adding multiple pairs of panels to either side. Mirror images of these configurations are also possible.

Center Pivot:

Additional Possibilities with SL45

When the width of stacked panels on the inside or the outside is a concern, the center pivot option reduces this problem by centering the stacked panels below the head jamb with almost equal protrusion to the inside and the outside. This is accomplished by placing the running carriages at the center of the panel instead of at the corners of the panels. Some limitations are that the end panels will need to be about half the width of the other panels, use of swing panels is limited and the maximum panel sizes possible are smaller. There will also be 2 point locking bolts and handles on almost all the panels.

To be able to support the panels, the upper rail would generally need to be wider than the standard upper rail width. Use of half width panels can be avoided by using unhinged panels (panels not hinged to a side jamb). Unhinged panels have to be an odd amount.

Use of the center pivot option is generally not recommended as the operation of the panels is not as intuitive as a system with panels folding inward or outward.

Shown below are elevation drawings and horizontal cross-section schematics of some possible configurations.

Examples: As there can be many other possibilities, please submit your ideas and sketches to NanaWall Systems, Inc. for evaluation.

- Maximum Frame Height:** 8'2" (2500 mm)
- Maximum Panel Width Insulated Glazing:** 2'7" (800 mm)
- Maximum Panel Width Single Glazing:** 3'3"(1000 mm)

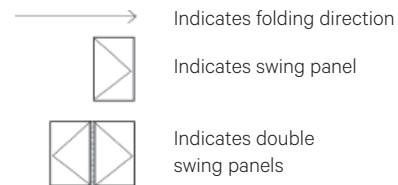

Model CI-2R

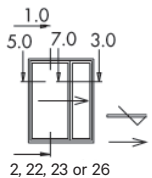

Model CI-3LR (unhinged)

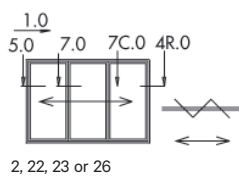

Model CI-1L2R

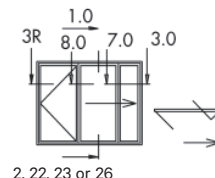

Model CI-4R

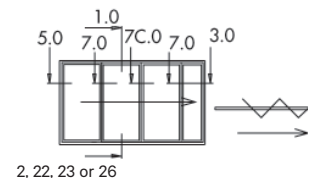

Model CI-2L2R

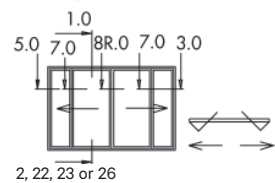

Model CI-1L3LR (unhinged)

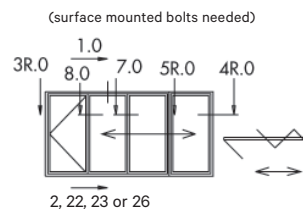

Model CI-1L3LR1R

(surface mounted bolts needed)

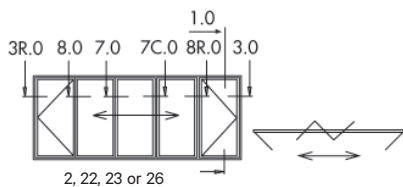

Model CI-1L3LR + A-1R

(surface mounted bolts needed)

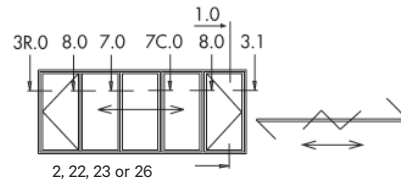

Model CI-3LR3LR

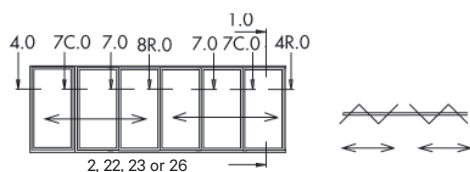

Model CI-3LR4R

(surface mounted bolts needed)

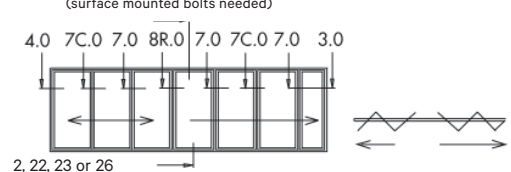

Segmented Curve Units:**Additional Configurations Possible with SL45 and SL70**

Possible with the SL45 system are changes in direction or angle of the head jamb and sill up to 22° between each panel, pair of folding panels or series of panels so that with multiple connections, the unit can have segmented curves. With the SL70, the maximum angle change is limited to 6.5°. Limitations as compared to straight units are as follows:

1. A segmented curve unit is not as weather resistant and may not withstand the same structural load.
2. Installation is more complicated and past experience in installing folding systems is recommended.
3. Besides frame dimensions, precise angles or radius need to be provided.
4. There are limitations as to which configurations are possible.
5. Costs are substantially more than standard straight units.
6. Stacking may not be as flat as straight units and stiles may not be straight.

Examples: As there can be many design possibilities, please submit your preliminary ideas and sketches to NanaWall Systems, Inc. for evaluation.

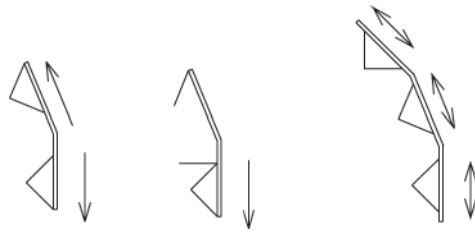
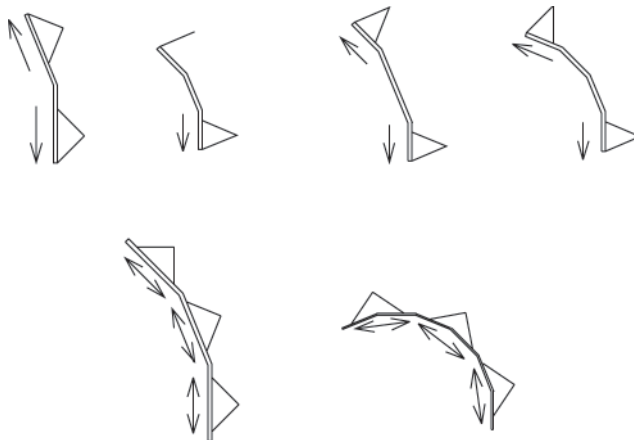
Inward Opening**Outward Opening**

Other configurations are possible and are derived from these above basic configurations. They are created by adding multiple pairs of panels to either side and having similar segments.

Some Panels Inward and Some Panels Outward:

Examples of Other Possibilities with SL45

Below are elevation drawings and horizontal cross-section schematics of some possible configurations.

Other configurations possible are made with the addition of one or more pairs of panels to either or both sides or flipping the inward or outward opening on either side.

“A” denotes outswing panels and “I” denotes inswing panels.

Please note that the width of panels that are inward opening can be different from the width of panels that are outward opening.

Examples: As there can be many other possibilities, please submit your ideas and sketches to NanaWall Systems, Inc. for evaluation.

Shown with Model A-1L + I-2R are the other three possibilities

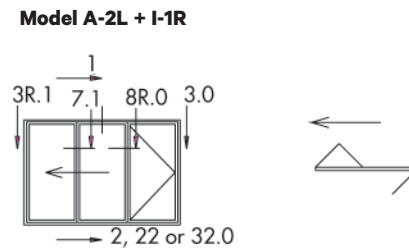
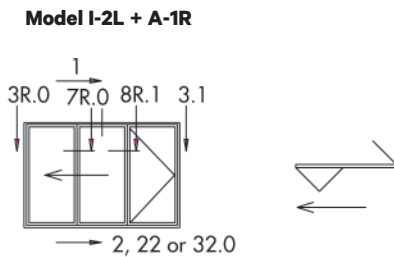
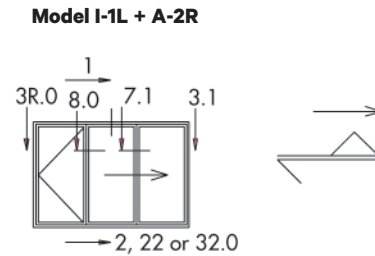
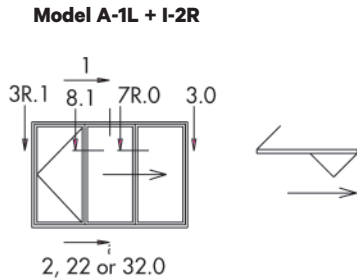
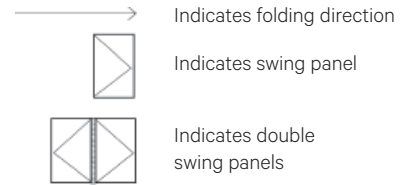

Other configurations for majority of panels folding to right with inward opening panels on the right

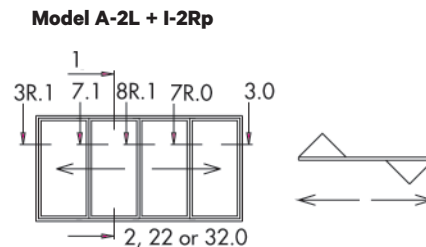
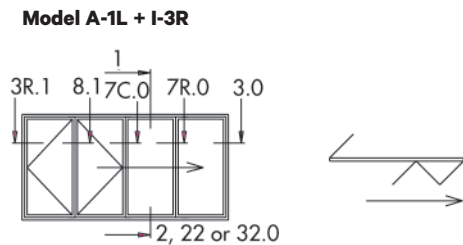

Folding Door / Window Combination in One Unit - Without a Fixed Post Separating the Doors from the Windows (NanaWall Kitchen Transition)

The Folding Door / Window combination opens wide, seamlessly turning a kitchen into an indoor / outdoor space. It can also be used in other types of applications.

Please note some limitations as follows:

1. Is only possible with certain systems, configurations and sills as shown below.
2. Lower corner where window meets door will not be as weather resistant as compared to a unit with all panels equal in height.
3. Please note that the location of the handle of the swing door panel has limitations due to the strike plate having to be either on the side jamb profile below the counter or on the adjacent window panel.
4. Handle heights of the door unit and window unit may be different.

Examples: As there can be many design possibilities, please submit your preliminary ideas and sketches to NanaWall Systems, Inc. for evaluation. (Please note that below are examples with just four of the folding configurations. Door / Window combinations are also possible with other configurations.)

Elevations Looking from inside

Even number of door panels meeting even number of window panels.

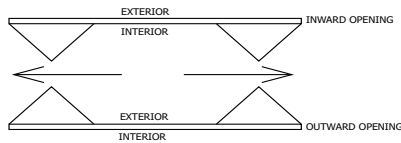
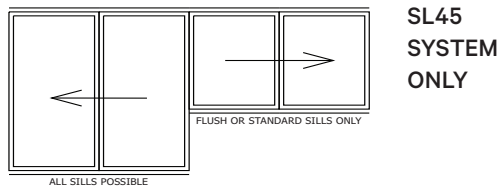

Odd number of door panels (with swing door) meeting odd number of window panels.*

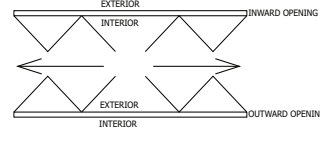
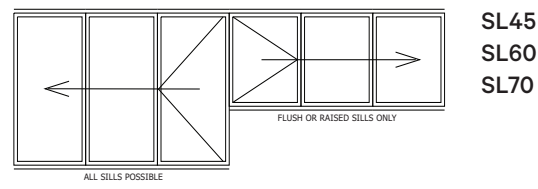

Odd number of door panels (with swing door) meeting even number of window panels.

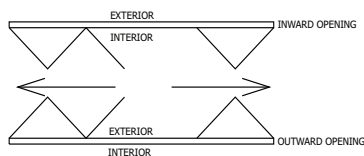
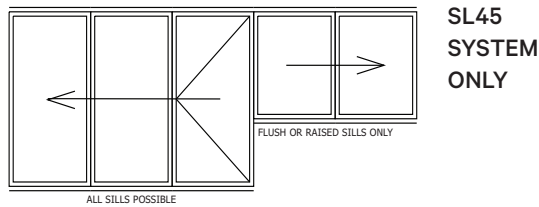

Even number of door panels meeting odd number of window panels.*

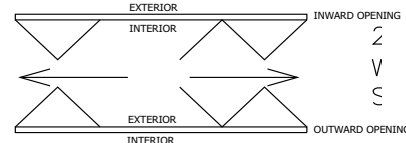
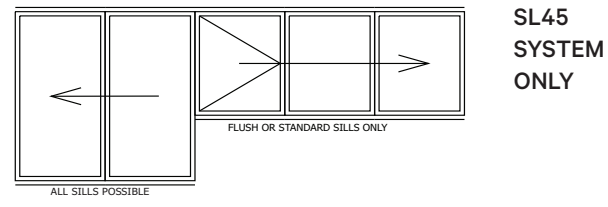

Based on the above basic configurations, other configurations are possible by adding (or subtracting) pairs of panels to either side.

*Please note that for outward opening units, operator will need to stand on the exterior to engage / disengage the window swing panel from the panel catch on the adjacent panel.