

Control Outdoor Elements Transparently



ClimaCLEAR™

Weather Resistant Frameless
Opening Glass Wall

NanaWall®
Boundaries **Unbound**™



ClimaCLEAR™ — Control Outdoor Elements Transparently



Tested and Rated
for Air and Water
Infiltration and
Structural Windload



Frameless All
Glass Single Track
Sliding System

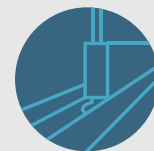

ADA-Compliant Sill
with Engineered Water
Management System

NanaWall ClimaCLEAR is the only frameless all glass individual panel sliding system specifically engineered for transparent weather protection. Patented (Patent No. US10590694), non-thermally broken single pane, ClimaCLEAR has been independently tested and rated, making it the choice for flexible space management solutions for outdoor spaces for both residential and commercial applications.

ClimaCLEAR allows for maximum transparency with no vertical stiles providing natural daylight, open views, and a clean, modern appearance making it suitable for all design styles. Whether the system is open or closed, it virtually disappears from sight. However, when the wall is closed, the beauty of an all glass aesthetic is realized with the added benefit of weather protection and acoustical privacy.

In moderate climates, ClimaCLEAR can be used to create an indoor/outdoor lifestyle in living rooms, dining rooms, and kitchens.

In colder climates, extend the seasonal enjoyment of outdoor patios, three season rooms, or porches with ClimaCLEAR frameless glass walls. Create a transparent shelter from the elements without inhibiting the connection to the outdoors while also providing protection for outdoor furniture.

In commercial settings or sport venue applications, ClimaCLEAR allows for maximum viewing and unobstructed sightlines even when closed.

BOUNDARIES UNBOUND

Through innovative NanaWall engineering, ClimaCLEAR is a fully transparent, structurally secure, weather-rated system for large openings. Comprised of exclusive proprietary features, some key components are:

Transparent Vertical Weather Seals

Standard between all sliding panels and single action end panels are super clear vertical seals to seal against wind driven rain and to reduce air infiltration. The seals virtually disappear from sight. Light transmittance (LT) of the weather seals has been independently tested and rated for 75% clarity and luminosity.

Patented (Patent No. US10590694) Panel Interlocks to Help Keep the Weather Out

Proprietary male/female panel interlocks at the top and bottom rails are designed to help keep the weather out. Panel floor bolts are foot activated effectively locking the panel into place without the need to kneel down.

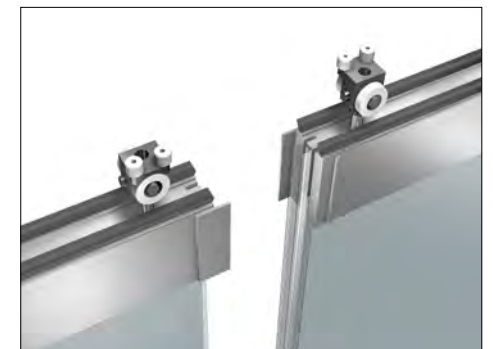

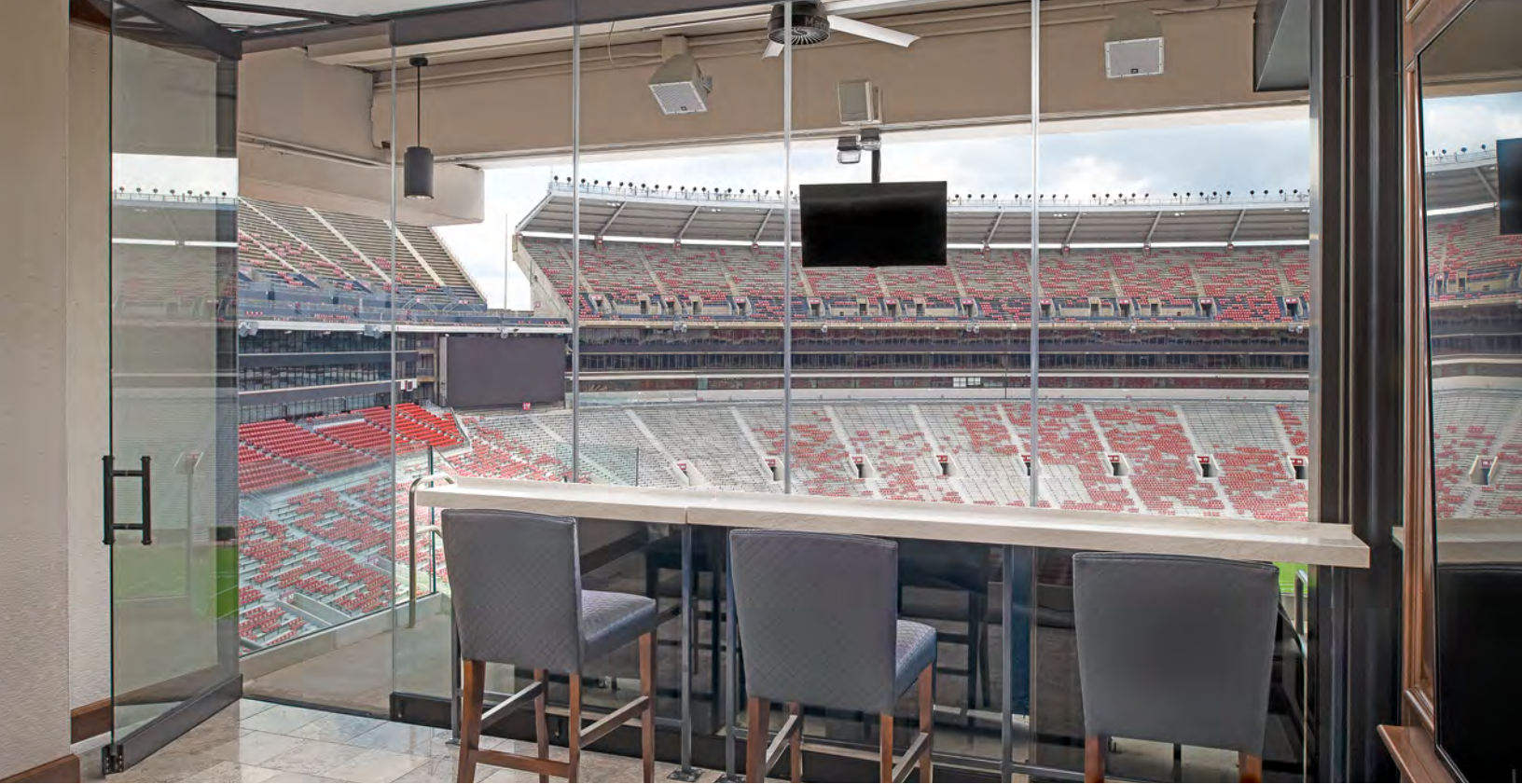

Horizontal Dual Sided Brush Seals

All horizontal continuous door rails come standard equipped with double fin brush seals on both sides, top and bottom, for weather protection.

Engineered Water Drainage System

ClimaCLEAR comes standard with a recessed low profile saddle sill that provides an engineered water management system. Weep holes for drainage by others are needed to inhibit water intrusion. The low profile saddle sill is ADA-compliant.

System Security

Structural integrity of the system is achieved through the combination of strong rollers, the clamping of the 1/2" (12 mm) monolithic glass, and through panel locking. Each closed panel of ClimaCLEAR can be securely locked in place.

Standard to the single action end panel is the Reverse Locking Ladder Pull handle/locking system with the handle starting at hand height and extending up to the top rail, outfitted with inside/outside locking and an additional lock at the bottom rail. The system has passed forced entry requirements.

Swing Door for Easy Egress

For easy access, ClimaCLEAR configurations come standard with a single action end panel equipped with a top door closer at the side jamb. The swing panel with offset hinge allows for a maximum 150° inswing or 110° outswing and has been commercially tested to 500,000 opening and closing cycles. ADA-compliant options available.

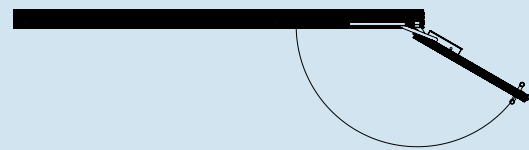

Intelligent Rollers Provide One Hand Operation

German engineered roller system ensures quiet, smooth, and trouble-free single hand operation by using an "intelligent" guiding system for moving individual panels.

Glazing Options

Standard glass supplied is 1/2" (12 mm) tempered. All vertical edges of the glass panels come polished. Also available is laminated glass for safety, security, acoustical separation, and/or UV protection in areas with lower structural requirements. Other options including low iron, frosted, tinted, and white glass are possible.

Custom Panel Sizes

Panels are available up to 10' 6" (3200 mm) in height, dependent on windload requirements, and up to 4' 1" (1250 mm) in width. Single action end panels are available up to 3' 7" (1100 mm) in width. Please confirm with local codes on height limits with 1/2" (12 mm) thick glass.

In tight stacking conditions where a swing door is not required, a minimal 1' 8" (500 mm) non-entry swing panel is available.

Single Track Sliding

Offering complex design flexibility, the single track individual panel design is able to create an **unlimited** span of top-hung panels for straight openings of any size. No "train station" effect from multiple floor tracks.

Parking Bay and Stacking Design Flexibility

To optimize space management, customizable stacking and parking bay options are possible.

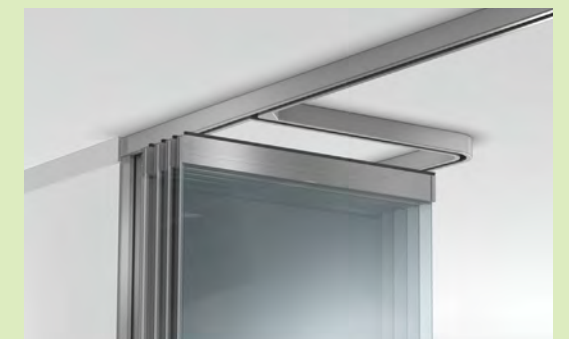



Example Configurations—Possible with Any Number of Panels

System stacking and single action end panel can be provided at either one end or both to accommodate traffic patterns. ClimaCLEAR is also available in 90° open corner and 135° segmented corner configurations.

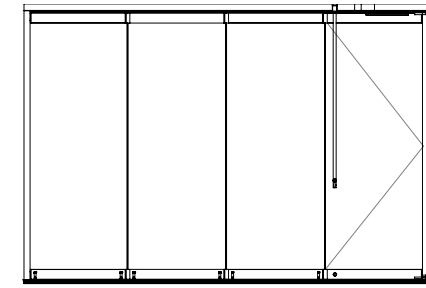

Single Action End Panel and Reverse Locking Ladder Pull Handle

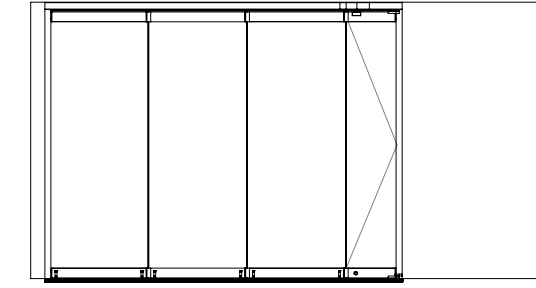

Non-Entry Single Action End Panel and Crank Handle Locking

Narrower panel option for more compact stacking.

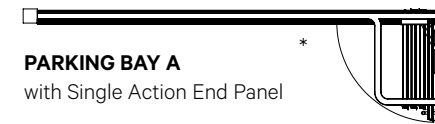

PARKING BAY A
with Single Action End Panel

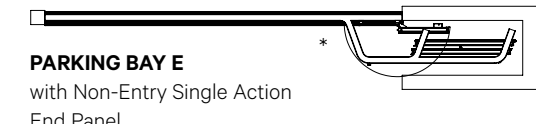

PARKING BAY E
with Non-Entry Single Action End Panel

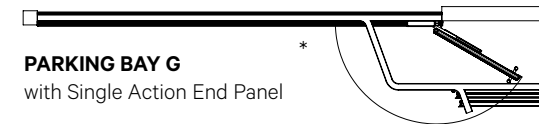

PARKING BAY G
with Single Action End Panel

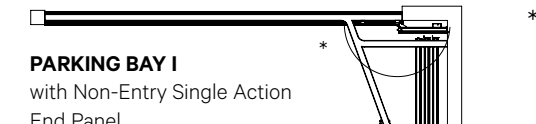

PARKING BAY I
with Non-Entry Single Action End Panel

* = INTERIOR

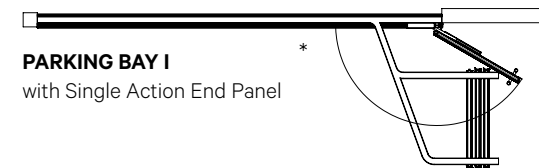

PARKING BAY I
with Single Action End Panel



Air Infiltration

as low as:

1.57 psf (75 Pa); **0.46** cfm/ft²



Water Penetration

No uncontrolled water entry
@ **3 psf** (150 Pa)



Structural Load Deflection

With panel height 8' 4" (2540 mm)

Positive @ **30** psf (1436 Pa)

Negative @ **30** psf (1436 Pa)



Forced Entry Resistance

AAMA 1304

Pass



Operation / Cycling Performance

Swing panel 500,000 cycles

Pass



Acoustical Performance

STC 34 OITC 28

with sound enhanced laminated glass

Finish Options*

Anodized Metal Options

ClimaCLEAR comes standard with a clear anodized finish.

To accommodate varying interior designs, brushed, dark bronze, and black anodized finishes are available.



Clear Anodized



Brushed Anodized



Dark Bronze Anodized



Black Anodized

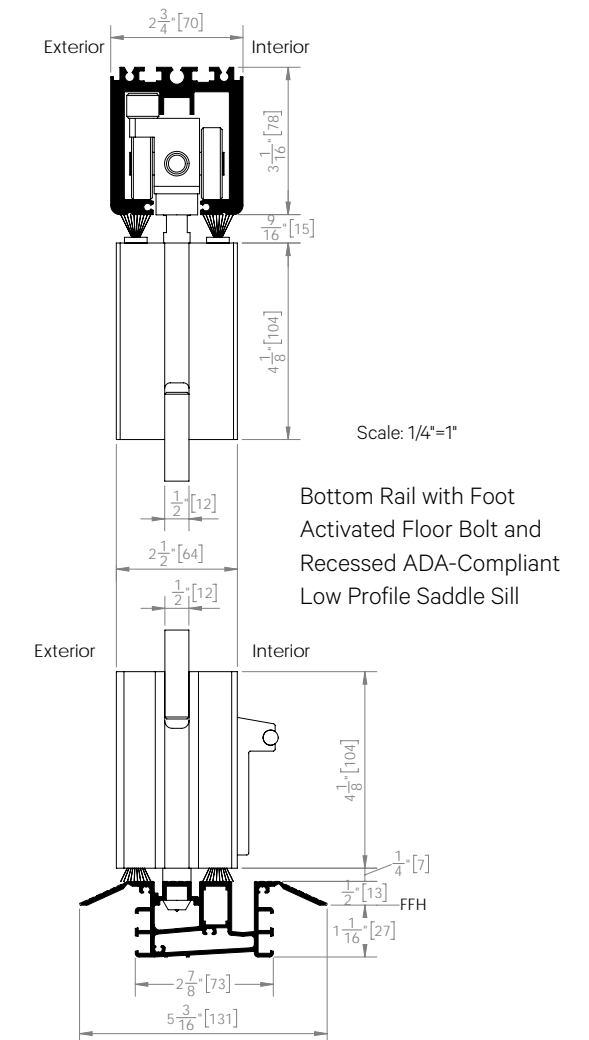

Scale: 1/4"=1"

Bottom Rail with Foot Activated Floor Bolt and Recessed ADA-Compliant Low Profile Saddle Sill

Please consult the ClimaCLEAR Architectural Binder for a detailed performance chart.

*Please contact NanaWall for powder coat, custom color, and mix and match options.

Control Outdoor Elements Transparently



Tested and Rated
for Air and Water
Infiltration and
Structural Windload



Frameless All
Glass Single Track
Sliding System

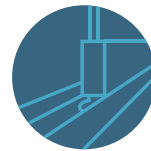

ADA-Compliant Sill
with Engineered Water
Management System

For design assistance on different parking bay possibilities, please refer to <https://www.nanawall.com/professionals/design-assistance>.

NanaWall Systems offers a complimentary 3D Conceptual Drawings service and 3D Configurator for CAD, Revit, and Specification during the design/development process.

Explore our opening glass wall product families:



Folding



Sliding



Minimal Sliding

THE ONE AND ONLY NANAWALL

At NanaWall, design is as much about how it looks as how it works. For over 35 years, we have been leading the industry in developing and refining our opening glass walls to create solutions that visually harmonize with space, transform the architectural experience, and provide decades of enduring performance.

NanaWall
Boundaries **Unbound**™

Nana Wall Systems, Inc.
100 Meadowcreek Drive #250
Corte Madera, CA 94925

800 873 5673
415 383 3148

info@nanawall.com
nanawall.com