

## The Aluminum Framed Monumental Folding/Paired Panel System

The SL45 is a monumental, standard aluminum folding or paired panel system. As a folding system, it is designed to provide an opening glass wall up to 43' wide. With additional paired panels, the width can be virtually unlimited with adequate support by others. It is a top hung system.

For benefits of all NanaWall systems, see the "General Introduction" section. For features common to aluminum folding systems, see the "Aluminum Folding Systems" Introduction.

### Stacking Configurations for Special Applications

Options exist for a variety of configurations: FoldFlat® against adjacent wall, all inward-opening panels, all outward-opening panels, some panels opening in, and some panels opening out. Unhinged paired panel options give maximum stacking flexibility. In addition, angled units of 90° and 135° or segmented units allow designers to create large bay or "curved" openings. To see these operable wall concepts in action, visit [www.nanawall.com/glass-walls/folding/sl45](http://www.nanawall.com/glass-walls/folding/sl45) and click the "Configure CAD/Revit" link.

### Monumental Sized System

Monumental sized panels are possible, with frame heights up to 9' 6" (2900 mm) and panel widths up to 3' 3" (1000 mm). Heavier and/or thicker glass (such as bullet-resistant laminated glazing) can be used (limitations on panel sizes).

### Florida Approval

The SL45 straight system with panel size of up to 36" x 98" is Florida statewide approved with Product Approval number FL37258. This information can be viewed at <http://www.floridabuilding.org>

### NFRC-Approved Thermal Performance

The SL45 has been rated, certified, and labeled in accordance with NFRC 100 and 200; see the "Performance and Testing Results" section for more details.

### Acoustical Performance

The SL45 system has been tested by an independent acoustic lab for acoustic performance. The SL45 with STC 37 laminated glass achieved STC and Rw values of 35.

### Rated Swing Panel

The Swing panel(s) or Egress door(s) within the system has been engineered for "normal" commercial traffic and has been independently tested to half a million opening and closing cycles per AAMA 920.



## General Description

The SL45 is a monumental, standard aluminum folding system designed to provide an opening glass wall or storefront up to 43' wide and a paired panel system for unlimited total width with adequate support by others; see Maximum Size Chart. The folding system is available in various configurations utilizing one to twelve panels or more with unhinged pairs of panels; see elevation drawings. The option exists for swing entry/exit panel(s), but note panel size constraints with a swing panel not hinged to a side jamb. There are many design possibilities; units can be either: all inward-opening or all outward-opening; some panels inward-opening and some panels outward-opening; see details in section drawings.

## Frame and Panels

The nominal extruded aluminum frame and panel thickness is 1 3/4" (45 mm); see section drawings. In addition to the choices from the NanaWall Powder Coating Finish Chart, the full range of RAL high gloss and matte powder coatings are available. Anodized and fluoropolymer kynar painted finishes are also available; see "Aluminum Finish Options" in the General Introduction.

Panels are pre-assembled, and all pins and screws needed to assemble frames are provided. On a folding pair of panels hinged to a side jamb, the panel hinged to the side jamb is 2" (52 mm) narrower in nominal width than the other panels.

Besides the standard sill that can match the frame finish, various flush sills (shown in section drawings) are available as an option in a clear or dark bronze anodized finish.

## Glazing

Units can be supplied either glazed with 1/4" (6 mm) single tempered or laminated glass; or 3/4" (20 mm) clear insulating tempered or insulating Low-E tempered glass or other high performing safety glass such as Heat Mirror, special tint, etc., or other glass on request. See "Glazing" in the General Introduction for other glass thickness possible. Various tints and Low E coatings are available.

## Weatherstripping

All weatherstripping (consisting of EPDM or brush seals) is provided for sealing between panels and between panel and frame; see section drawings.

## Sliding/Folding Hardware

For sliding and folding each pair of panels, a patented, load-bearing, upper-running carriage is attached to the upper corner of a panel; see section drawings. Attached to the lower corner is a lower-running carriage as a guide. The double pair, twin-tandem, upper-running carriage is constructed to ensure even pressure distribution on all four rollers. Rollers have sealed bearings and are coated with toughened Polyamide to ensure a quiet running and optimal resistance to extreme. Two to five hinges per connection are provided to connect panels together and to connect panels to frames. Finish for zinc die cast hinges would be closest powder coat match to panel profile. Available as an option are stainless steel hinges.

## Locking Hardware and Handle Options

For each pair of folding panels (except for the pair to be opened first in a unit with no swing panel) and on the secondary swing panel, provided is two-point locking hardware consisting of top and bottom Polyamide capped locking rods operated by a 180° turn of a flat handle on the inside only. Locking is independently tested for structural, air, water, and forced entry.

If there is a **swing panel**, there are the following hardware options on the main entry panel:

- 1. Multi-point Locking.** Consisting of lever handles on both sides, a lockset, lockable latch, deadbolt, and rods at the top and the bottom. After turn of key or thumbturn, depression of handles withdraws latch, lifting engages rods, and turn of key or thumbturn engages deadbolt and locks. Available with European profile cylinder or an adapter to accommodate a 5-7 pin SFIC core (SFIC core supplied by others).
- 2. Deadbolt Lock.** Consisting of push/pull handles on both sides with deadbolt(s) operated by a lockset. Turn of key or thumb turn operates lock. Available is a lockset option of having key operation on both sides. Secured with European profile cylinder or an adapter to accommodate a 5-7 pin SFIC core (SFIC core supplied by others). To keep the panel closed, a door closer should be field installed, but note that a door closer by others can only be installed for a swing panel that is attached to the side jamb.
- 3. Single Action, Emergency Access, Interconnected Locking.** For interior application, single-point single motion locking operated by GU Rhondo lever handles with European profile cylinder or an adapter to accommodate a 5-7 pin SFIC core (SFIC core supplied by others). Depression of handle withdraws deadbolt and latch.

To meet wind load requirements for exterior use during high wind conditions, additional one point locks operated by separate handles can be provided at the top and bottom. In severe storm conditions, these can be engaged; however, the locking no longer qualifies for emergency access during this instance.

**4. No Hardware.** For panic hardware to be prepped, supplied, and installed by others, the main entry panel can be supplied with no locking hardware. With this option, the tested applicable design windload pressures will not be applicable.

For a unit **with no swing panel**, on the folding pair to be opened first, provided is two-point locking hardware consisting of top and bottom Polyamide capped locking rods operated by a 180° turn of an L-shaped handle for an inward opening unit and a flat handle for an outward opening unit on the inside. In both cases, there will be a flat handle on the outside. Lockable with a lockset. Turn of key or thumb turn operates lock. Please note that for an outward opening unit, locking from the inside will need to be with a key that may not meet egress requirements.

For a unit where locking/handles on the inside only is desired, like in window applications, on all swing panels or pair of folding panels to be opened first, provided is two-point locking with a flat handle on the inside only.

#### **Handle Finish Schemes:**

Standard - Stainless steel lever, flat, and L-shaped handles in brushed satin or black titanium finish.

Push/pull handles are in brushed stainless steel.

Optional - Brass lever handles in oil rubbed, satin nickel, or white finish and flat handles closest powdercoat match to panel aluminum finish.

## Standard Sill SL45

TYPE OF TEST	INWARD OPENING UNITS	OUTWARD OPENING UNITS
 <b>Air Infiltration</b> <sup>①</sup> ASTM E-283, cfm/ft <sup>2</sup>	@ <b>1.57</b> psf (75 Pa): <b>0.27</b>	@ <b>1.57</b> psf (75 Pa): <b>0.27</b>
 <b>Water Penetration</b> <sup>②</sup> ASTM E-547	No uncontrolled water entry @ <b>1.56</b> psf (75 Pa)*  *Subject to one 3/8" diameter weep hole per panel in front face of sill by others.	No uncontrolled water entry @ <b>1.56</b> psf (75 Pa)*  *Subject to one 3/8" diameter weep hole per panel in front face of sill by others.
 <b>Structural Load Deflection</b> ASTM E-330: pass  <b>See Design Windload Charts for other sized panels</b> <i>Note that the structural test pressures were 50% higher than the design pressures.</i>  <i>(Based on low profile saddle sill testing as per engineer's evaluation letter).</i>	<b>DESIGN PRESSURE</b>  Positive @ <b>35</b> psf (1675 Pa)	<b>DESIGN PRESSURE</b>  Negative @ <b>35</b> psf (1675 Pa)
 <b>Operation / Cycling Performance</b> <sup>③</sup> AAMA 920	<b>For swing panel attached to the side jamb:</b> 500,000 cycles - pass	
 <b>Forced Entry Resistance</b> <sup>①</sup>	In accordance with Protocol TAS 202 (300 lb. Pull Test)	
 <b>Acoustical Performance</b> <sup>④</sup>	The SL45 with STC 40 laminated glass achieved STC and Rw values of 36.	

① Excerpts of results of a 9' 6" W x 8' 6½" H three panel unit with saddle sill tested by Architectural Testing, Inc., Fresno CA an independent testing laboratory in August 2006.

② Excerpts of results of 10' 9" W x 8' 2" H three panel unit with Standard Sill tested by Architectural Testing Inc., Fresno CA an independent testing laboratory, in November 1999.

③ Excerpts of results of a system tested by Architectural Testing, Inc., Fresno CA, an independent testing laboratory in April 2012.

④ Excerpts of results of a unit tested by Nusing Mobile Trennwandtechnik, Munster, Germany, an independent testing laboratory in December 2011.

# Standard Sill

## SL45



### Thermal Performance

Rated, certified and labeled in accordance with NFRC 100 + 200

TYPE OF GLASS (1 LITE) ⑤	CENTER OF GLASS U-FACTOR	IG GLASS THICKNESS	UNIT U-FACTOR	SHGC ⑥	VT ⑦
Double IG Clear (air filled)	.48	13/16" (20 mm)	.67	.56	.58
Double IG Low E (argon filled)	.26	13/16" (20 mm)	.51	.21	.44
Double IG Low E (air filled)	.30	13/16" (20 mm)	.54	.22	.44
Double IG Low E on #2/#4 surfaces (argon filled)	.21	13/16" (20 mm)	.48	.21	.43
Double IG Low E on #2/#4 surfaces (air filled)	.24	13/16" (20 mm)	.50	.21	.43
1/4" Single Glazed	1.02	1/4" (6 mm)	1.03	.61	.63
1/4" Single Low E on the interior surface	—	1/4" (6 mm)	.79	.56	.61

#### NOTES

⑤ NFRC simulated U factors of units with a horizontal mullion will have values of .01 to .03 higher than units with no horizontal mullion. Please contact NanaWall for details.

⑥ SHGC = Solar Heat Gain Coefficient

⑦ VT = Visible Transmittance

Call NanaWall for U-Factor & SHGC for other glass types.

# Low Profile Saddle Sill

## SL45

TYPE OF TEST	INWARD OPENING UNITS	OUTWARD OPENING UNITS
 <b>Air Infiltration</b> <sup>①</sup> ASTM E-283, cfm/ft <sup>2</sup>	@ <b>1.6</b> psf (75 Pa): <b>0.25</b>	@ <b>1.6</b> psf (75 Pa): <b>0.25</b>
 <b>Water Penetration</b> <sup>①</sup> ASTM E-547	<p>No uncontrolled water entry @ <b>3.76</b> psf (180 Pa) subject to the following adaptations of the sill in the field by others:</p> <ol style="list-style-type: none"> <li>1. Remove the gaskets covering the inner channel.</li> <li>2. Drill weep holes through the bottom of this channel (about one 3/8" weep hole per panel.)</li> <li>3. Drill weep holes through the lower front face of the sill to drain water collected to a lower point (about one 3/8" circular weep hole per panel.)</li> </ol> <p>Please note that due to varying site requirements and conditions, these sills will not be prepared for drainage by Nana Wall Systems, Inc. If this drainage system is desired, we recommend that a qualified professional construct this system on the project site strictly in accordance with NanaWall instructions and good waterproofing techniques.</p> <p>Note that in some applications drain connections may not be possible.</p>	
 <b>Structural Load Deflection</b> <sup>①</sup> ASTM E-330: pass <b>See Design Windload Charts for other sized panels</b> <i>Note that the structural test pressures were 50% higher than the design pressures.</i>	<b>DESIGN PRESSURE</b>  Positive @ <b>35</b> psf (1765 Pa)	<b>DESIGN PRESSURE</b>  Negative @ <b>35</b> psf (1765 Pa)
 <b>Operation / Cycling Performance</b> <sup>②</sup> AAMA 920	<b>For swing panel attached to the side jamb:</b> 500,000 cycles - pass	
 <b>Forced Entry Resistance</b> <sup>①</sup>	In accordance with AAMA-1303.5 and CAWM 300 requirements.	
 <b>Acoustical Performance</b> <sup>③</sup>	The SL45 with STC 40 laminated glass achieved STC and Rw values of 36.	

① Excerpts of results of a 9' 6" W x 8' 6½" H three panel unit with saddle sill tested by Architectural Testing, Inc., Fresno CA an independent testing laboratory in August 2006.

② Excerpts of results of a system tested by Architectural Testing, Inc., Fresno CA, an independent testing laboratory in April 2012.

③ Excerpts of results of a unit tested by Nusing Mobile Trennwandtechnik, Munster, Germany, an independent testing laboratory in December 2011.

# Low Profile Saddle Sill

## SL45



### Thermal Performance

Rated, certified and labeled in accordance with NFRC 100 + 200

TYPE OF GLASS (1 LITE) <sup>④</sup>	CENTER OF GLASS U-FACTOR	IG GLASS THICKNESS	UNIT U-FACTOR	SHGC <sup>⑤</sup>	VT <sup>⑥</sup>
Double IG Clear (air filled)	.48	13/16" (20 mm)	.68	.56	.58
Double IG Low E (argon filled)	.26	13/16" (20 mm)	.52	.21	.45
Double IG Low E (air filled)	.30	13/16" (20 mm)	.55	.22	.45
Double IG Low E on #2/#4 surfaces (argon filled)	.21	13/16" (20 mm)	.49	.21	.43
Double IG Low E on #2/#4 surfaces (air filled)	.24	13/16" (20 mm)	.51	.21	.43
1/4" Single Glazed	1.02	1/4" (6 mm)	1.04	.61	.63
1/4" Single Low E on the interior surface	—	1/4" (6 mm)	.80	.56	.62

#### NOTES

④ NFRC simulated U factors of units with a horizontal mullion will have values of .01 to .03 higher than units with no horizontal mullion. Please contact NanaWall for details.



⑤ SHGC = Solar Heat Gain Coefficient

⑥ VT = Visible Transmittance

Call NanaWall for U-Factor & SHGC for other glass types.

# Flush Sill

## SL45

TYPE OF TEST	INWARD OPENING UNITS	OUTWARD OPENING UNITS
 <b>Air Infiltration</b> <sup>①</sup> ASTM E-283, cfm/ft <sup>2</sup>	@ <b>1.6</b> psf (75 Pa): <b>0.25</b>	@ <b>1.6</b> psf (75 Pa): <b>0.25</b>
 <b>Structural Load Deflection</b> <sup>①</sup> ASTM E-330: pass <b>See Design Windload Charts for other sized panels</b> <i>Note that the structural test pressures were 50% higher than the design pressures.</i> <i>(Based on low profile saddle sill testing as per engineer's evaluation letter).</i>	<b>DESIGN PRESSURE</b> Positive @ <b>35</b> psf (1675 Pa)	<b>DESIGN PRESSURE</b> Negative @ <b>35</b> psf (1675 Pa)
 <b>Operation / Cycling Performance</b> <sup>②</sup> AAMA 920	<b>For swing panel attached to the side jamb:</b> 500,000 cycles - pass	
 <b>Forced Entry Resistance</b> <sup>①</sup>	In accordance with AAMA-1303.5 and CAWM 300 requirements.	
 <b>Acoustical Performance</b> <sup>③</sup>	The SL45 with STC 40 laminated glass achieved STC and Rw values of 36.	

① Excerpts of results of a 9' 6" W x 8' 6½" H three panel unit with saddle sill tested by Architectural Testing, Inc., Fresno CA an independent testing laboratory in August 2006.

② Excerpts of results of a system tested by Architectural Testing, Inc., Fresno CA, an independent testing laboratory in April 2012.

③ Excerpts of results of a unit tested by Nusing Mobile Trennwandtechnik, Munster, Germany, an independent testing laboratory in December 2011.



# Flush Sill

## SL45



### Thermal Performance

Rated, certified and labeled in accordance with NFRC 100 + 200

TYPE OF GLASS (1 LITE) ④	CENTER OF GLASS U-FACTOR	IG GLASS THICKNESS	UNIT U-FACTOR	SHGC⑤	VT⑥
Double IG Clear (air filled)	.48	13/16" (20 mm)	.67	.56	.58
Double IG Low E (argon filled)	.26	13/16" (20 mm)	.51	.21	.45
Double IG Low E (air filled)	.30	13/16" (20 mm)	.54	.22	.45
Double IG Low E on #2/#4 surfaces (argon filled)	.21	13/16" (20 mm)	.48	.21	.43
Double IG Low E on #2/#4 surfaces (air filled)	.24	13/16" (20 mm)	.50	.21	.43
1/4" Single Glazed	1.02	1/4" (6 mm)	1.03	.62	.64
1/4" Single Low E on the interior surface	—	1/4" (6 mm)	.79	.57	.62

#### NOTES

④ NFRC simulated U factors of units with a horizontal mullion will have values of .01 to .03 higher than units with no horizontal mullion. Please contact NanaWall for details.

⑤ SHGC = Solar Heat Gain Coefficient

⑥ VT = Visible Transmittance

Call NanaWall for U-Factor & SHGC for other glass types.

## SL45

TYPE OF TEST	RESULTS
 <p>Acoustical Performance <sup>①</sup></p>	STC 30 (Rw 31) and OITC 27 achieved with STC 32 glass (1/4" [6 mm])
	STC (Rw) 35 and OITC 30 achieved with STC 37 glass (5/16" [8 mm] laminated)

① Excerpts of results of a three panel unit 9' 10" W x 8' 2" H (3000 mm x 2500 mm) tested in August 2019 by SG Bauakustik, Muelheim an der Ruhr, Germany, an EN DIN ISO accredited and certified independent testing laboratory.

**Check [www.NanaWall.com](http://www.NanaWall.com) for the latest updates.**

### Acoustical Performance Interpolation with Other Glazing Options

TYPE OF GLASS	GLASS ONLY STC	FLUSH SILL	
		COMPLETE SYSTEM STC (Rw)	MAXIMUM UNIT HEIGHT POSSIBLE
1/4" (6 mm) tempered	31	30	9' 6" (2900 mm)
1/4" (6 mm) laminated	35	33	9' 6" (2900 mm)
1/4" (6 mm) enhanced laminated	36	34	9' 6" (2900 mm)

**Contact NanaWall for other glass types**

**SL45 Standard Unit**

**Positive and Negative Design Pressures for Both Inward and Outward Opening Units.**

(In Accordance with Allowable Stress Design (ASD) Design Pressures\*)

(Derived From Comparative Analysis)  
 Test Unit Size: 9' 6" W x 8' 6 1/2" H  
 (3 panels)

Please note that some jurisdictions may limit the use of these charts or may not accept them at all. Design pressures and/or sizes may be restricted to what was tested. For Florida approved products, please see detailed FL Evaluation Report for restrictions. This chart is only applicable for units with referenced NanaWall supplied locking.

\* If the project design pressures have been calculated in accordance with Ultimate Design Wind Speed (ULT), then these design pressures have to be multiplied by a factor of 0.6 to obtain the equivalent ASD design pressures shown in this chart.

**Allowable Design Wind Loading - PSF**

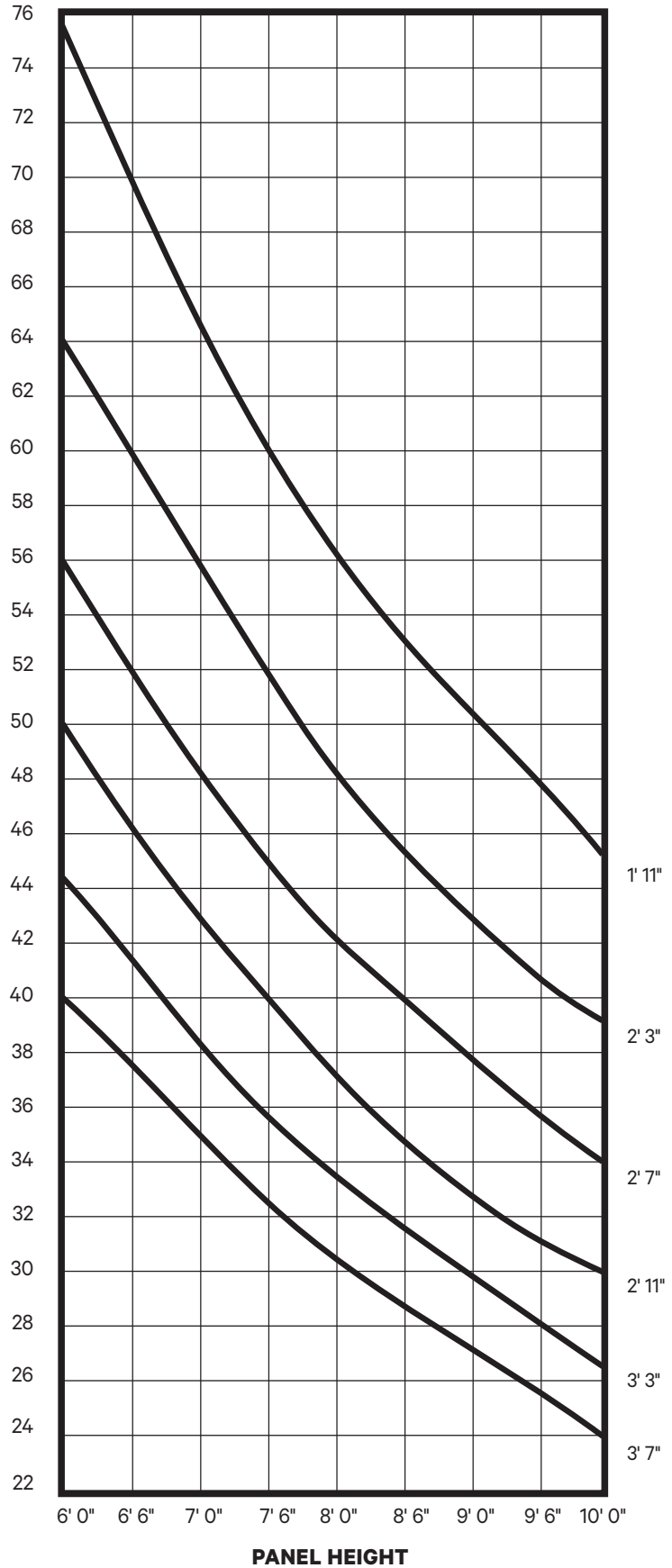

See Maximum Frame Size Chart for Possible Sizes.

NOTE: English Dimensions are approximate. Dimensions in parenthesis are in millimeters

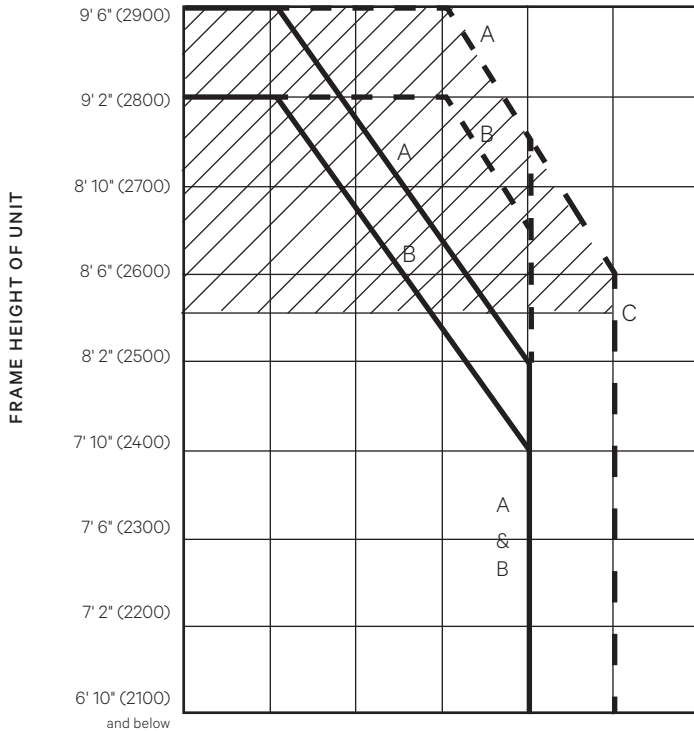

NUMBER OF PANELS IN UNIT	FRAME WIDTH OF UNIT					
	1' 11\"/>					
1	1' 11\"/>	2' 3\"/>	2' 7\"/>	2' 11\"/>	3' 3\"/>	widths not possible
2	3' 11\"/>	4' 7\"/>	5' 3\"/>	5' 10\"/>	6' 6\"/>	7' 2\"/>
3	5' 10\"/>	6' 10\"/>	7' 10\"/>	8' 10\"/>	9' 10\"/>	widths not possible
4	7' 10\"/>	9' 2\"/>	10' 6\"/>	11' 9\"/>	13' 1\"/>	14' 5\"/>
5	9' 10\"/>	11' 5\"/>	13' 1\"/>	14' 9\"/>	16' 4\"/>	widths not possible
6	11' 9\"/>	13' 10\"/>	15' 8\"/>	17' 8\"/>	19' 8\"/>	21' 7\"/>
7	13' 10\"/>	16\"/>	18' 4\"/>	20' 7\"/>	22' 10\"/>	widths not possible
8	15' 8\"/>	18' 4\"/>	20' 11\"/>	23' 6\"/>	26' 1\"/>	28' 10\"/>
9	20' 11\"/>	20' 7\"/>	23' 6\"/>	26' 5\"/>	29' 4\"/>	widths not possible
10	19' 8\"/>	22' 10\"/>	26' 1\"/>	29' 4\"/>	32' 9\"/>	36' 1\"/>
11	21' 7\"/>	25' 1\"/>	28' 8\"/>	32' 5\"/>	36' 1\"/>	widths not possible
12	23' 7\"/>	27' 4\"/>	31' 5\"/>	35' 5\"/>	39' 4\"/>	43' 3\"/>

Units with up to twelve panels are shown on the graph below. With additional unhinged paired panels, virtually unlimited unit widths are possible. Any custom panel size is possible up to the maximum size shown.

The total overall unit width is the number of panels multiplied by the individual panel width. As a guide, the table below shows some examples with the number of panels multiplied by selected panel widths.

— Solid dark line on chart indicates maximum frame height possible for a given maximum frame width with double glazing.

- - - Broken line on chart indicates maximum frame height possible for a given maximum frame width with single glazing.



A horizontal mullion is needed for a unit with a frame height that is more than 8' 4" (2550 mm).

**A.** Single or Double Glazed either for configurations with folding panels only or for configurations with folding panels and a swing door hinged to a side jamb – includes Models 1L, 1R, 1L1R, 2L, 2R, 1L2R, 4L, 4R, 1L6R, 2L2R, 1L4R, 2L4R, 6R, 2L6R, 4L4R, 4L6R, 2L1R, 4L1R, 4L2R, 6L, 6L1R, 6L2R, 6L4R & 6L6R.

**B.** For all configurations.

**C.** On chart indicates the following additional limitation: no unit with swing panel allowed. Only the following configurations allowed: 2R, 4R, 2L2R, 2L4R, 6R, 2L6R, 4L4R, 4L6R, 2L, 4L, 4L2R, 6L, 6L2R, 6L4R, 6L6R.

If larger sized panels are needed, please consider the SL70 system.

The maximum size limits for double glazed are based on the maximum weight of a panel being 5.5 lbs/sq ft (this weight is based on using standard insulated glass with a net glass thickness of 5/16" (8 mm) or 5/32" (4 mm) for each glass pane). The maximum size limits for single glazed units are based on a glass thickness of 1/4" (6 mm). For other net thicker glass, this maximum size chart will not apply.

**For configurations with no swing panels, the minimum panel width needed is 1' 8" (510 mm).**

# Interior Size Chart SL45: UNIT STC 30 to STC 34

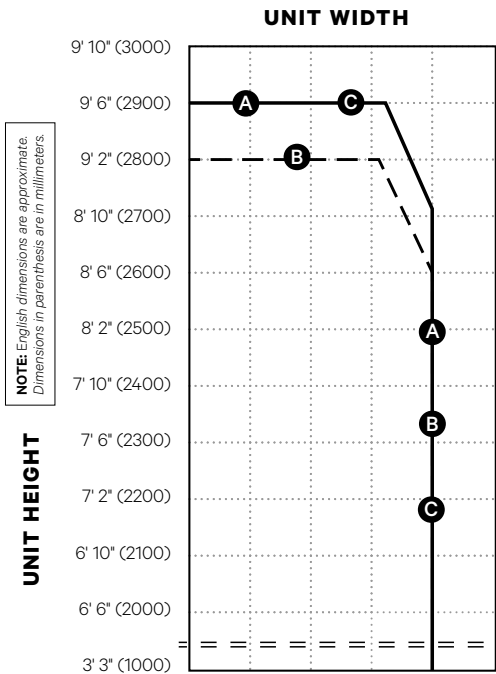

Number of Panels in Unit

1	1' 11" (600)	2' 3" (700)	2' 7" (800)	2' 11" (900)	3' 3" (1000)
2	3' 11" (1200)	4' 7" (1400)	5' 3" (1600)	5' 10" (1800)	6' 6" (2000)
3	5' 10" (1800)	6' 10" (2100)	7' 10" (2400)	8' 10" (2700)	9' 10" (3000)
4	7' 10" (2400)	9' 2" (2800)	10' 6" (3200)	11' 9" (3600)	13' 1" (4000)
5	9' 10" (3000)	11' 5" (3500)	13' 1" (4000)	14' 9" (4500)	16' 4" (5000)
6	11' 9" (3600)	13' 10" (4200)	15' 8" (4800)	17' 8" (5400)	19' 8" (6000)
7	13' 10" (4200)	16' 0" (4900)	18' 4" (5600)	20' 7" (6300)	22' 10" (7000)
8	15' 8" (4800)	18' 4" (5600)	20' 11" (6400)	23' 6" (7200)	26' 1" (8000)
9	17' 9" (5400)	20' 7" (6300)	23' 6" (7200)	26' 5" (8100)	29' 4" (9000)
10	19' 8" (6000)	22' 10" (7000)	26' 1" (8000)	29' 4" (9000)	32' 9" (10000)
11	21' 7" (6600)	25' 1" (7700)	28' 8" (8800)	32' 5" (9900)	36' 1" (11000)
12	23' 6" (7200)	27' 4" (8400)	31' 5" (9600)	35' 5" (10800)	39' 4" (12000)

**Frame Width of Unit**

(Wider widths possible with addition of Panel Sets.)

Any Custom Size is Possible Up to the Maximum Size Limit Lines Shown

**FOR UNIT STC 30 - 34 (max. 3 lbs/ft<sup>2</sup> [15 kg/m<sup>2</sup>])  
MAXIMUM SIZE LIMIT LINE OF:**

**A CONFIGURATIONS** ———  
(Swing panel at jamb only.)

**Standard Configurations:**

1L	1L 1R	1L 4R	2L 1R	4L 1R	6L 1R
1R	1L 2R	1L 6R			

**Sample Configurations with Unhinged TwoFold or FourFold Panel Sets:**

1L 2L/R	1L 4L/R 1R	4L/R 1R
---------	------------	---------

Addition of Panel Sets to all A Configurations possible.

**B CONFIGURATIONS** - - -  
(Swing panel as part of odd number of panels.)

**Standard Configurations:**

3L	5L	1L 3R	3L 2R	5L 1R	4L 3R	5L 3R	5L 4R	5L 6R
3R	5R	3L 1R	3L 3R	2L 5R	5L 2R	3L 6R	6L 3R	6L 5R
		2L 3R	1L 5R	3L 4R	3L 5R	4L 5R	5L 5R	

**Sample Configurations with Unhinged TwoFold or FourFold Panel Sets:**

3L 2L/R	3L 4L/R	3L 4L/R 3R
---------	---------	------------

Addition of Panel Sets to all B Configurations possible.

**C CONFIGURATIONS** ———  
(No swing panels.)

**Standard Configurations:**

2L	4L	6L	2L 2R	4L 2R	6L 2R
2R	4R	6R	2L 4R	4L 4R	6L 4R
			2L 6R	4L 6R	6L 6R

**Sample Configurations with Unhinged TwoFold or FourFold Panel Sets:**

2L 2L/R	4L/R 4R	6L 4L/R	4L/R 4L/R	2L/R 4L/R
---------	---------	---------	-----------	-----------

Addition of Panel Sets to all C Configurations possible.

**GLAZING**

- Different glass thicknesses from 3/16" (4 mm) to 5/16" (8 mm).
- Dry glazing system.

**NOTES**

- Max. panel width swing panel attached to side jamb 3' 3" (1000 mm).
- Min. panel width 23 5/8" (600 mm) for C Configurations.
- Min. panel width 21 5/8" (550 mm) for Panel Sets 2L/R, 4L/R.
- For special sizes and configurations, contact NanaWall.

**Dimensions in millimeters unless noted. Calculation applies to the standard stiles and rails.**

**Glass dimensions of all panels in a unit are equal, except for glass width of panel(s) that is hinged to either side jamb that has at least one other panel hinged to it. This glass width is 52 mm (2 1/16") less than the glass width of other panels.**

Nominal Panel Height (PH) is defined as Glass Daylight Opening Height + 110 (4 5/16")

Nominal Panel Width (PW) is defined as Glass Daylight Opening Width + 110 (4 5/16")

Panel Height is as seen from the inside on an inward opening unit and is as seen from the outside on an outward opening unit.

See Cross-Section Details of both stiles of each panel to determine actual Panel Width. With astragals, overlapping, etc., the actual Panel Width not only varies with position of panel in a configuration, but the inside and outside surface widths of each stile may be different.

For each configuration, the Frame Width (FW) is the sum of the nominal Panel Width (PW) times the number of panels minus 52 mm x number of panels hinged to side jamb with at least one other panel hinged to it plus a number (N) which is the sum of the side jamb dimensions and dimensions of space between panels in excess of the nominal Panel Width as shown in the Cross-Section Details.

**Frame Height (FH)**

**SL45 System**

Standard Sill:

Frame Height = Panel Height + 108 (4 1/4") = Clear Opening Height + 94 (3 11/16")

Flush/Low Profile Sill:

Frame Height = Panel Height + 118 (4 11/16") = Clear Opening Height + 104 (4 1/8")

Surface Mounted Sill:

Frame Height = Panel Height + 101 (4") = Clear Opening Height + 87 (3 71/6")

**Frame Widths for Different Configurations with Majority of Panels Folding to Right (and their Mirror Image**

**Configurations with Majority of Panels Folding to Left). See Maximum Size Charts for size limits.** These numbers can be used as a guideline only. Contact NanaWall for the exact calculations for a particular unit.

Please note that widths for units with unhinged panels or angle turns will be different.

Model 1R	Frame Width = 1 x Panel Width + 92 = 1 x Panel Width + 3 5/8"
Model 1L1R	Frame Width = 2 x Panel Width + 100 = 2 x Panel Width + 3 15/16"
Model 2R*	Frame Width = 2 x Panel Width - 52 + 100 = 2 x Panel Width + 1 7/8"
Model 3R*, Model 1L2R*	Frame Width = 3 x Panel Width - 52 + 107 = 3 x Panel Width + 2 3/16"
Model 4R*, Model 1L3R*	Frame Width = 4 x Panel Width - 52 + 115 = 4 x Panel Width + 2 1/2"
Model 2L2R**	Frame Width = 4 x Panel Width - 104 + 115 = 4 x Panel Width + 7/16"
Model 5R*, Model 1L4R*	Frame Width = 5 x Panel Width - 52 + 122 = 5 x Panel Width + 2 3/4"
Model 2L3R**	Frame Width = 5 x Panel Width - 104 + 122 = 5 x Panel Width + 3/4"
Model 3L3R**, Model 2L4R**	Frame Width = 6 x Panel Width - 104 + 130 = 6 x Panel Width + 1"
Model 1L5R*, Model 6R*	Frame Width = 6 x Panel Width - 52 + 130 = 6 x Panel Width + 3 1/16"
Model 3L4R**, Model 2L5R**	Frame Width = 7 x Panel Width - 104 + 137 = 7 x Panel Width + 1 5/16"
Model 1L6R*	Frame Width = 7 x Panel Width - 52 + 137 = 7 x Panel Width + 3 3/8"
Model 4L4R**, Model-3L5R**, Model 2L6R**	Frame Width = 8 x Panel Width - 104 + 145 = 8 x Panel Width + 1 5/8"
Model 4L5R**, Model-3L6R**	Frame Width = 9 x Panel Width - 104 + 152 = 9 x Panel Width + 1 15/16"
Model 4L6R**, Model 5L5R**	Frame Width = 10 x Panel Width - 104 + 160 = 10 x Panel Width + 2 3/16"
Model 5L6R**	Frame Width = 11 x Panel Width - 104 + 167 = 11 x Panel Width + 2 1/2"
Model 6L6R**	Frame Width = 12 x Panel Width - 104 + 175 = 12 x Panel Width + 2 13/16"
Model 4L5R**, Model 3L6R**	Frame Width = 9 x Panel Width - 120 + 213 = 9 x Panel Width + 3 11/16"
Model 4L6R**	Frame Width = 10 x Panel Width - 120 + 225 = 10 x Panel Width + 4 1/8"
Model 5L5R**	Frame Width = 10 x Panel Width - 120 + 223 = 10 x Panel Width + 4 13/16"
Model 5L6R**	Frame Width = 11 x Panel Width - 120 + 233 = 11 x Panel Width + 4 7/16"
Model 6L6R**	Frame Width = 12 x Panel Width - 120 + 245 = 12 x Panel Width + 4 15/16"

\* One end panel that is 52 mm (2") narrower than other panels \*\* Two end panels that are 52 mm (2") narrower than other panels

**Detail 1.0** Head Jamb

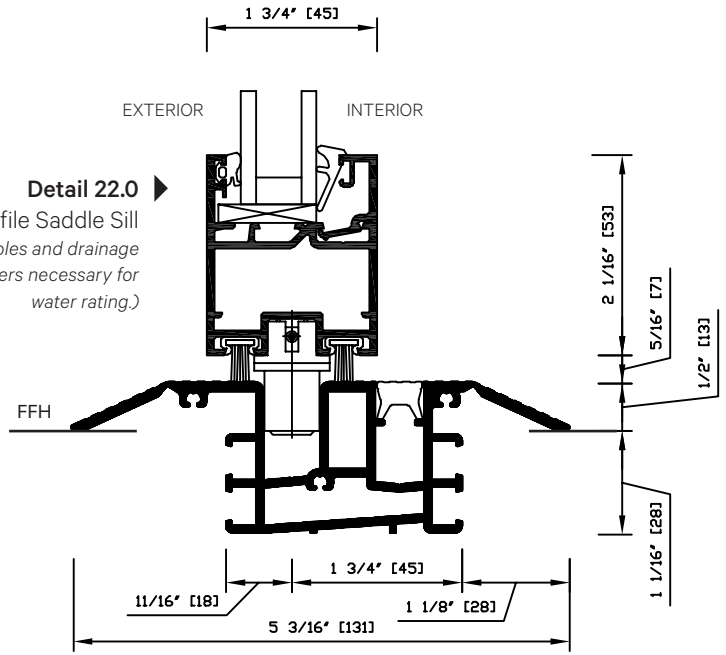
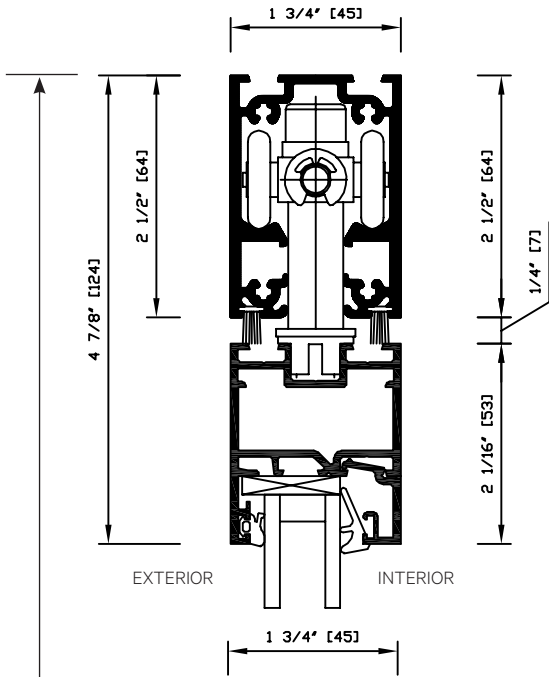

**Detail 22.0** ▶  
Low Profile Saddle Sill  
(Weep holes and drainage by others necessary for water rating.)

Frame Height

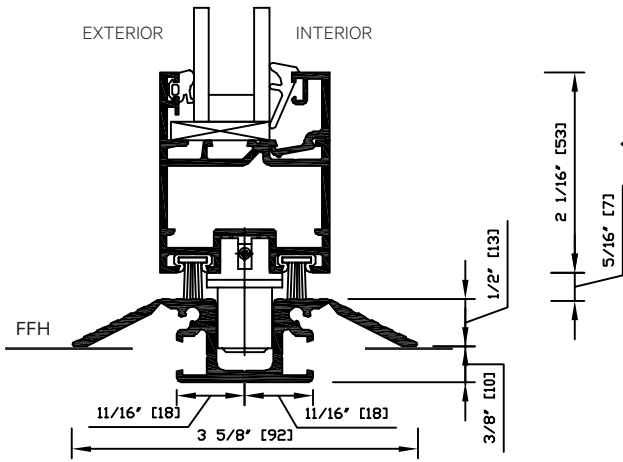

◀ **Detail 23.0**  
Surface Mounted Interior Sill

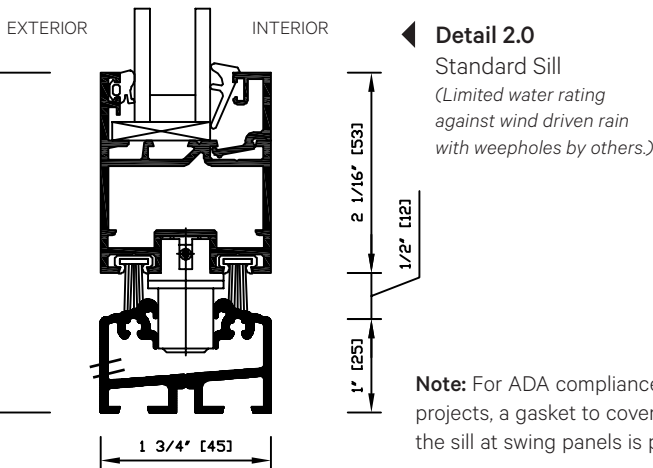

◀ **Detail 2.0**  
Standard Sill  
(Limited water rating against wind driven rain with weepholes by others.)

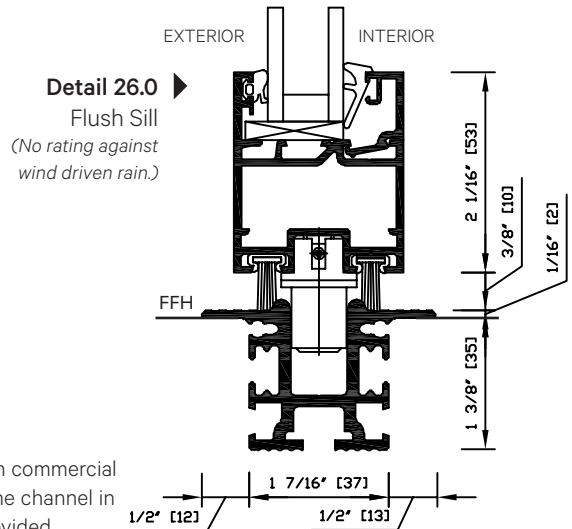

**Detail 26.0** ▶  
Flush Sill  
(No rating against wind driven rain.)

**Note:** For ADA compliance in commercial projects, a gasket to cover the channel in the sill at swing panels is provided.

**Detail 3.0** Panel hinged at right side jamb

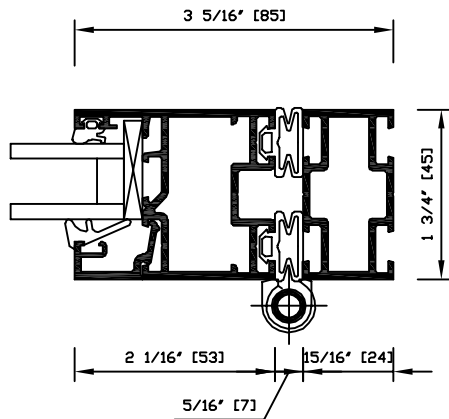

**Detail 3R.0** Panel hinged at left side jamb

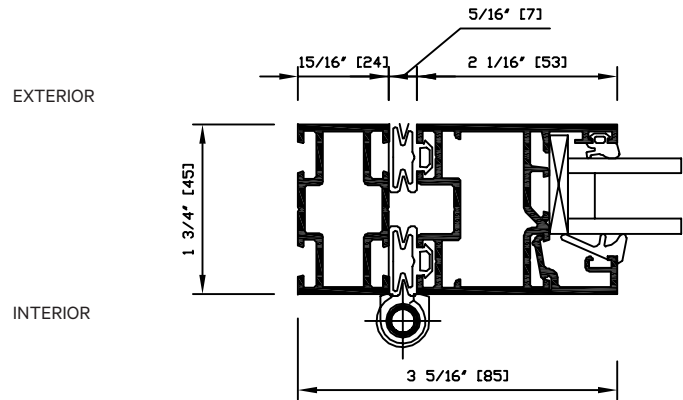

**Detail 4.0** Swing panel with locking at left side jamb

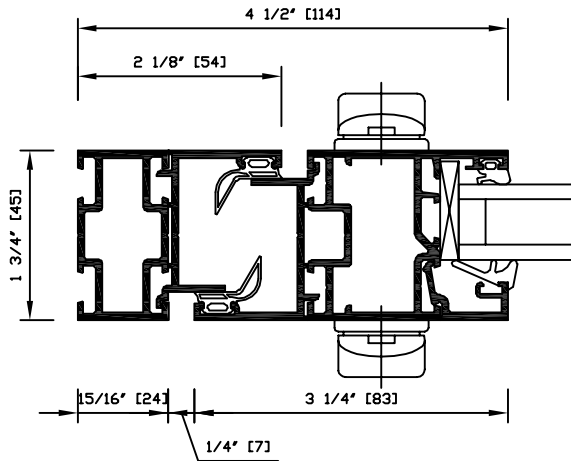

**Detail 4R.0** Swing panel with locking at right side jamb

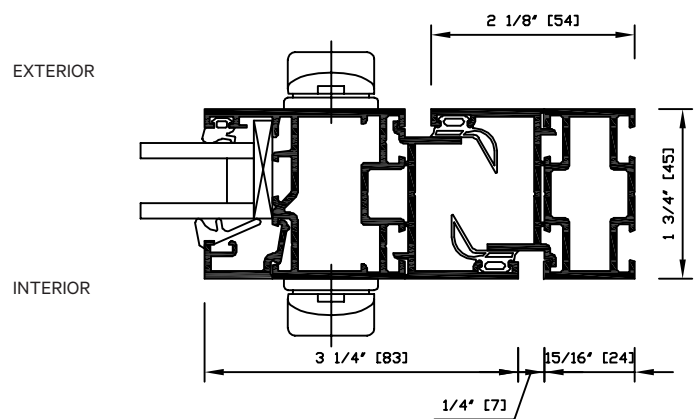

**Detail 5.0** Panel with running carriage set meeting left side jamb.

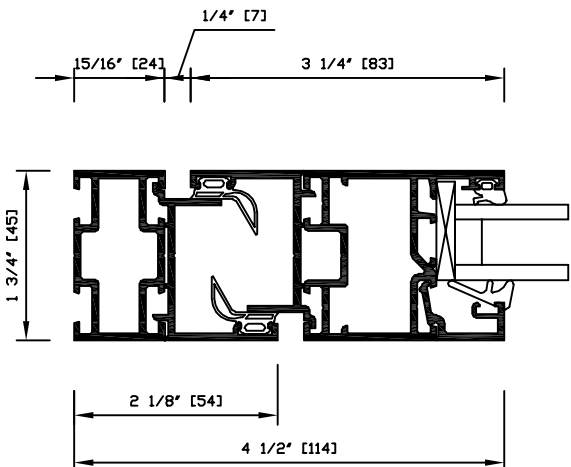

**Detail 5R.0** Panel with running carriage set meeting right side jamb.

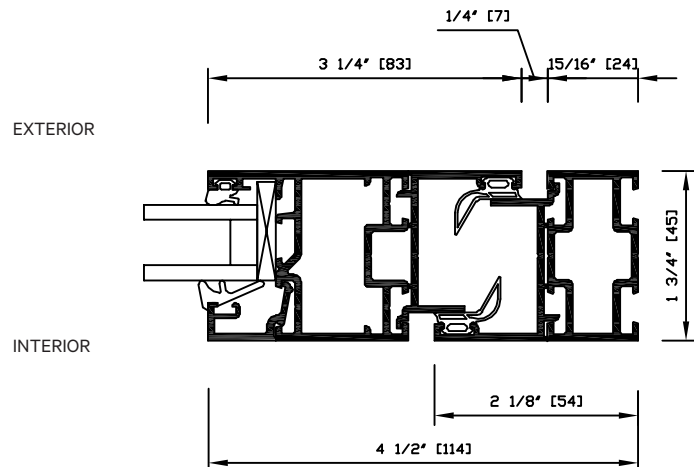



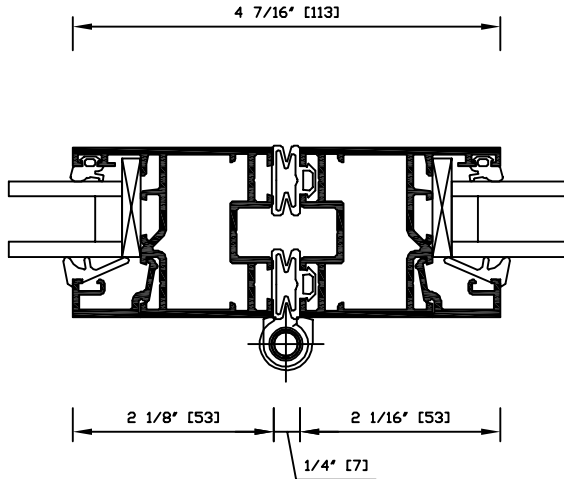

**Detail 7C.0 & 7RC.0**  
Folding panels with running carriage set

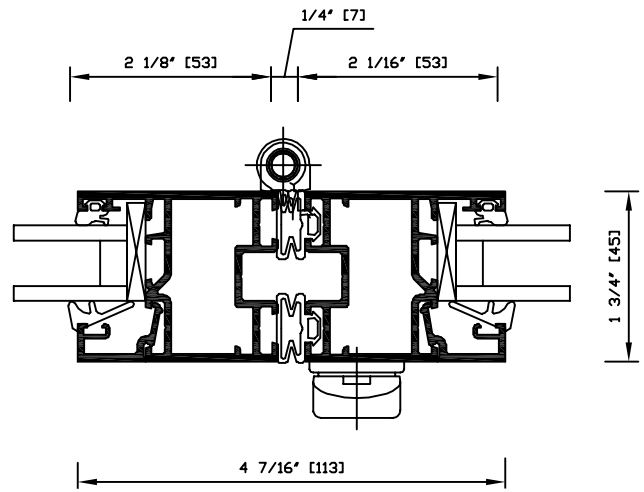

**Detail 7.0 & 7R.0**  
Folding panel with locking  
(Handle may be on left panel.)

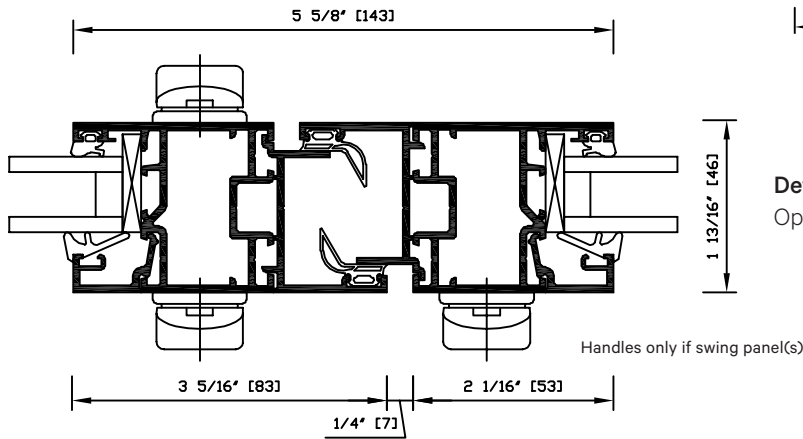

**Detail 8.0, 9.0, & 10.0**  
Opening Point of Panels

Handles only if swing panel(s)

**Detail 8R.0, 9R.0, & 10R.0**  
Opening Point of Panels

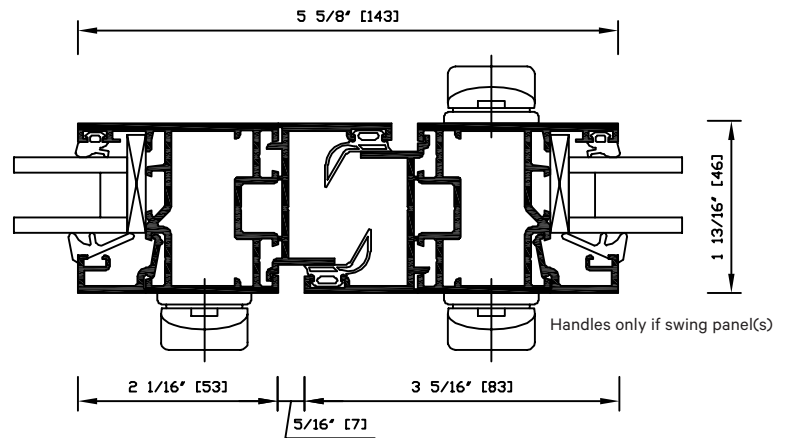

Handles only if swing panel(s)

**Detail 1.1** Head Jamb

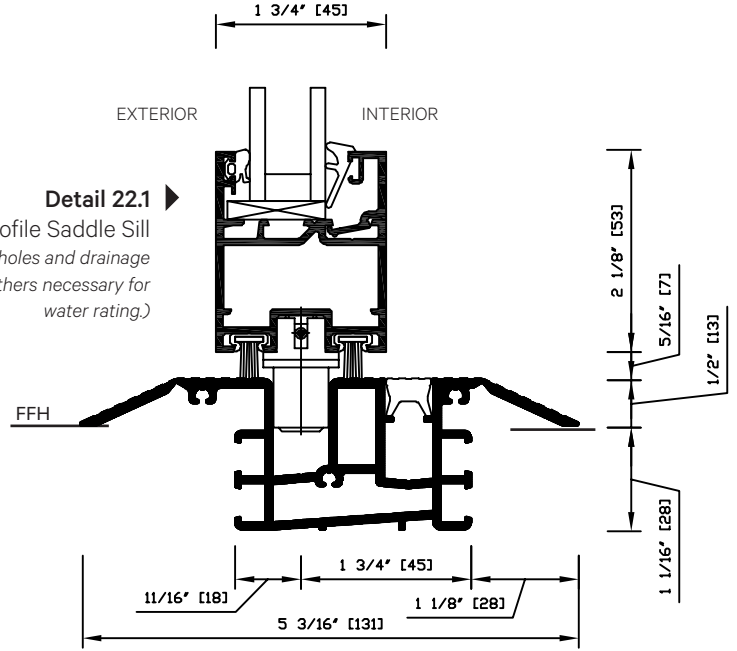
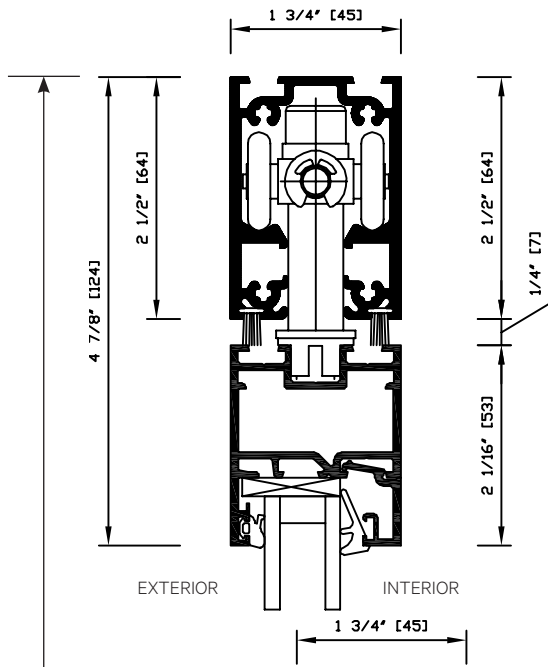

**Detail 23.1** Surface Mounted Interior Sill

Frame Height

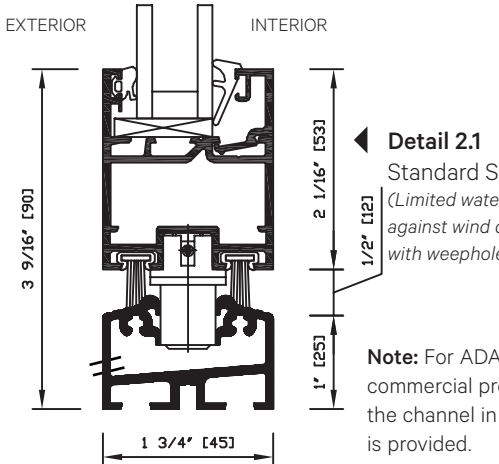
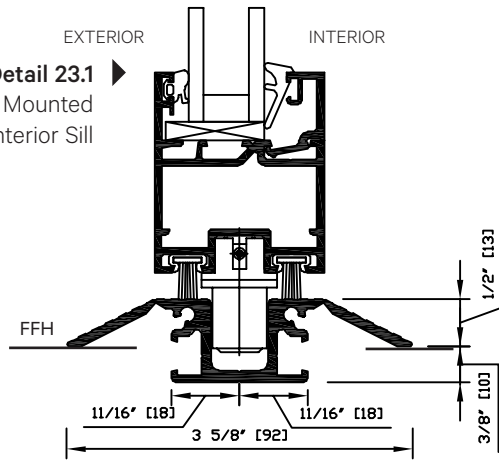

**Detail 2.1** Standard Sill  
(Limited water rating against wind driven rain with weepholes by others.)

**Note:** For ADA compliance in commercial projects, a gasket to cover the channel in the sill at swing panels is provided.

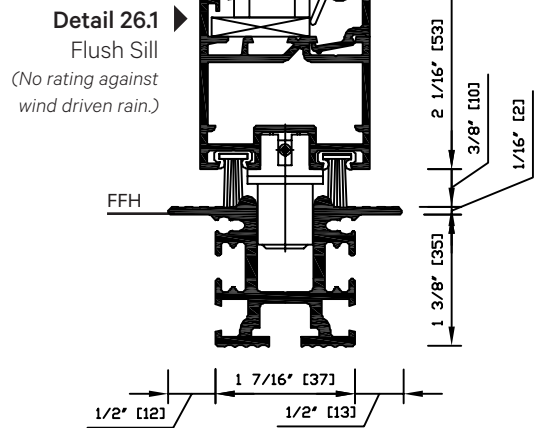

**Detail 26.1** Flush Sill  
(No rating against wind driven rain.)

**Detail 3R.1** Panel hinged at left side jamb

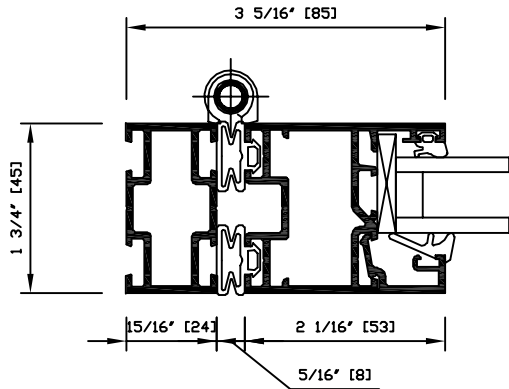

**Detail 3.1** Panel hinged at right side jamb

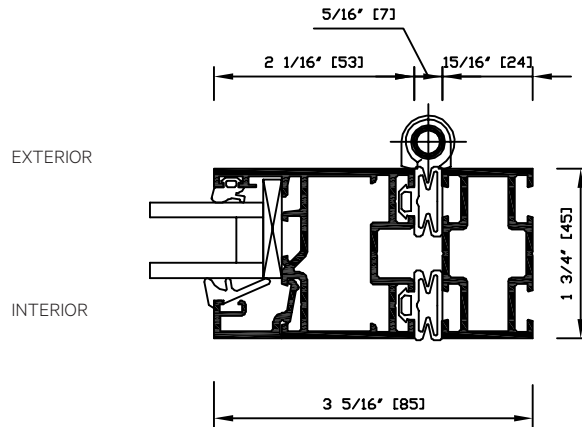

**Detail 4.1** Swing panel with locking at left side jamb

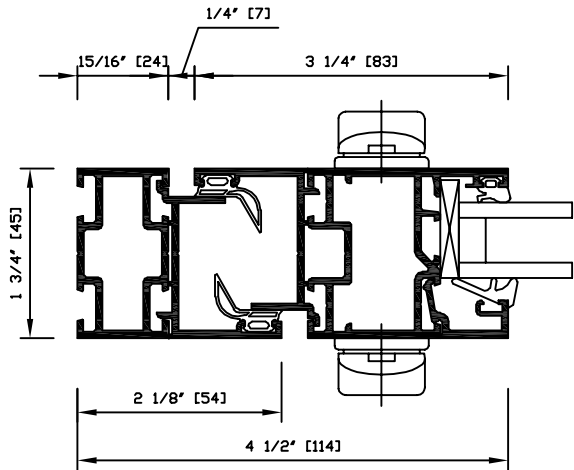

**Detail 4R.1** Swing panel with locking at right side jamb

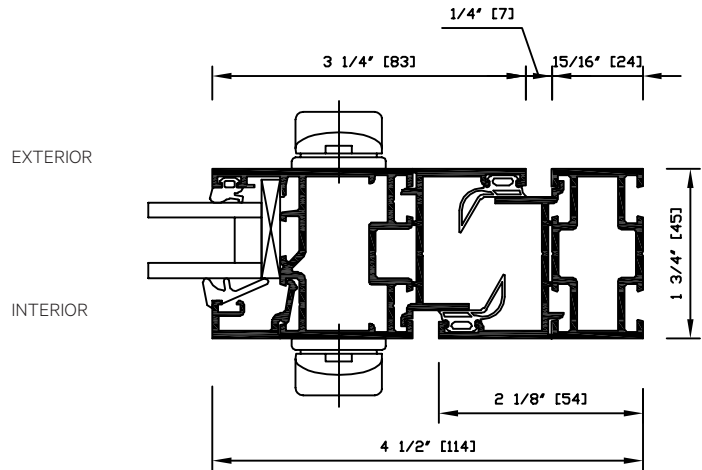

**Detail 5.1** Panel with running carriage set meeting left side jamb

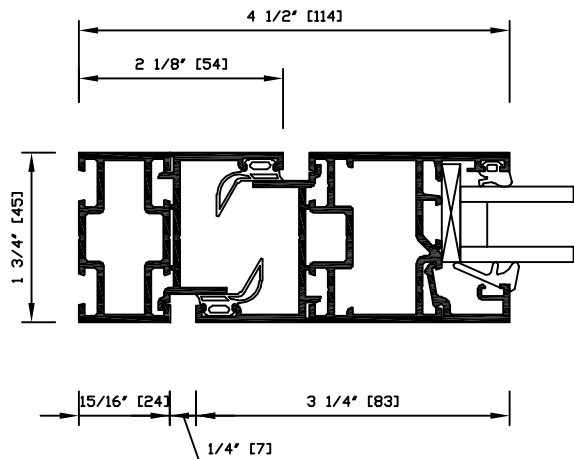

**Detail 5R.1** Panel with running carriage set meeting right side jamb

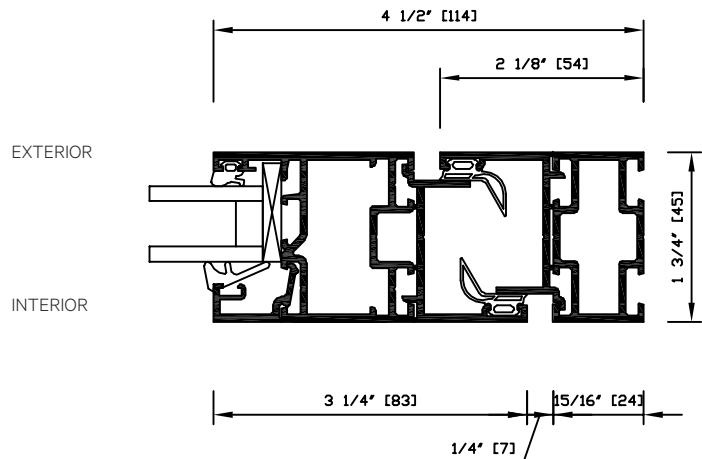

**Detail 7C.1 & 7RC.1**

Folding panels with running carriage set

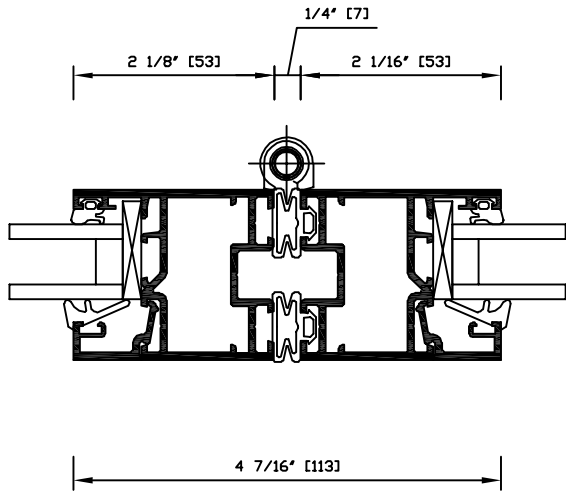

**Detail 7.1 & 7R.1**

Folding panel with locking

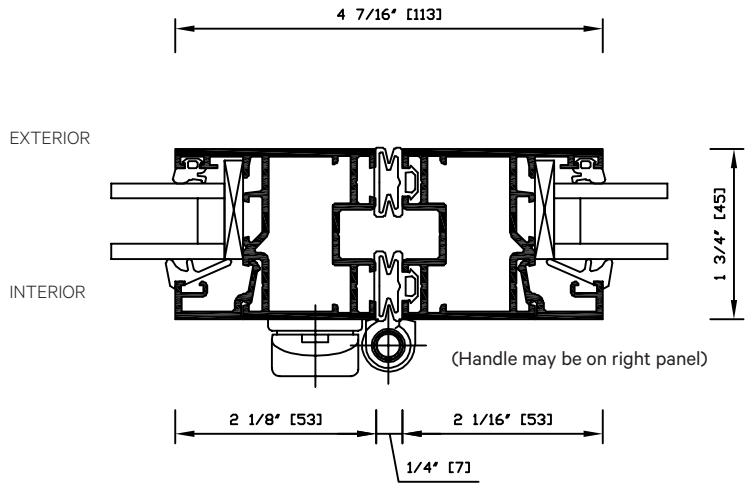

**Detail 8R.1, 9R.1, & 10R.10**

Opening Point of Panels

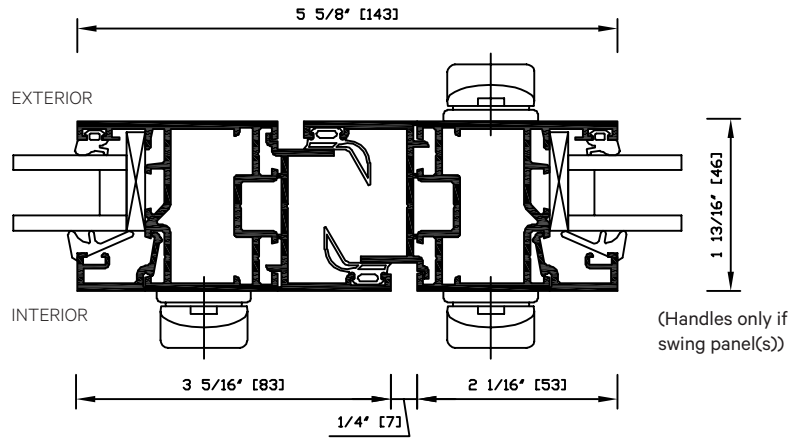

**Detail 8.1, 9.1, & 10.1**

Opening Point of Panels

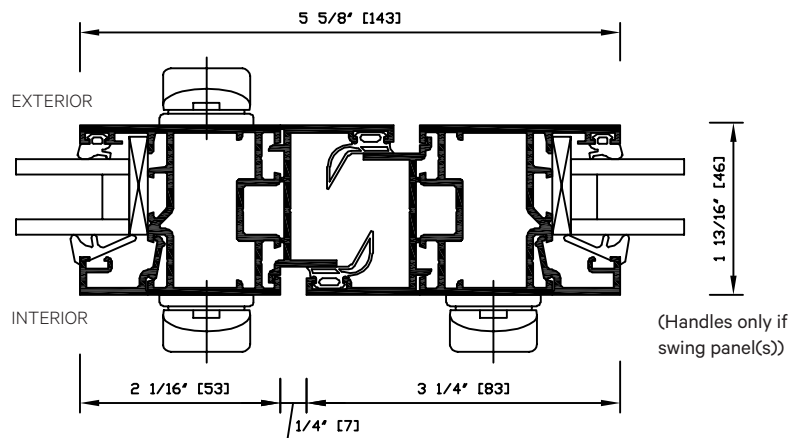

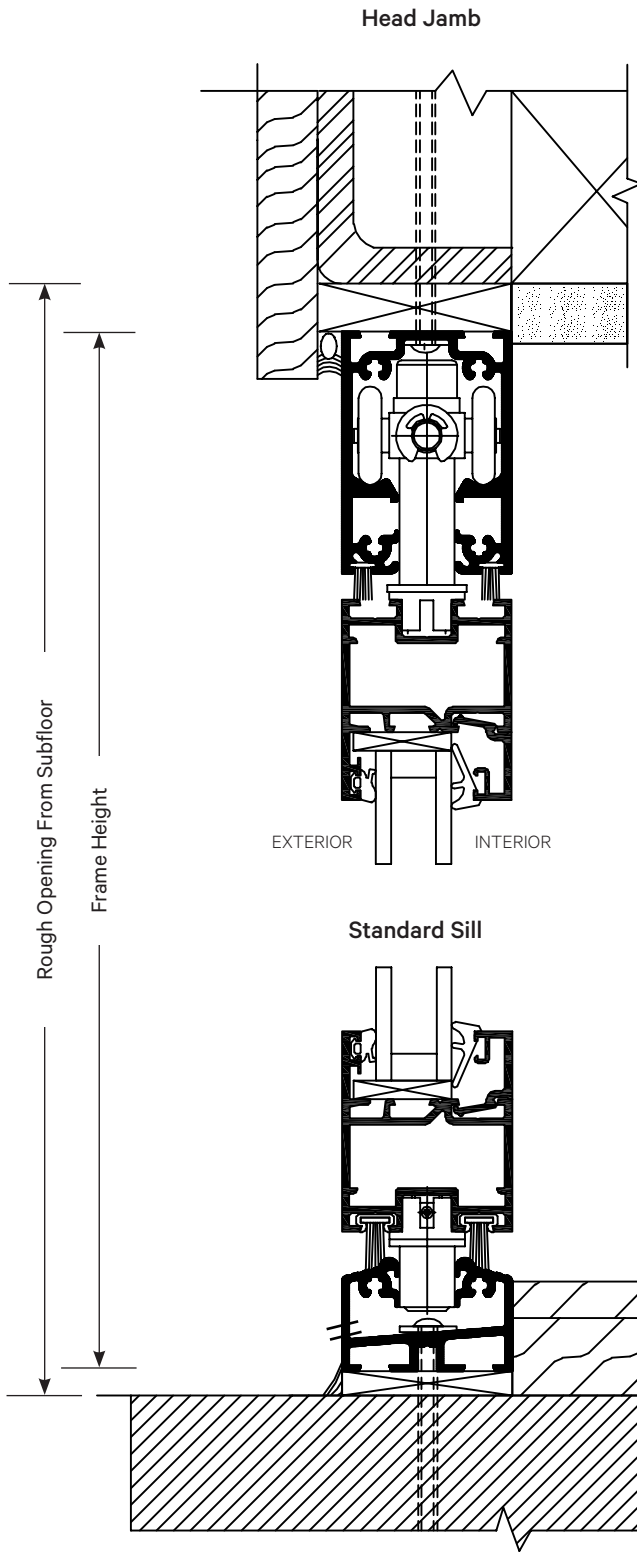

See Installation Notes on Next Page

Inward Opening Panel Hinged At Right Side Jamb

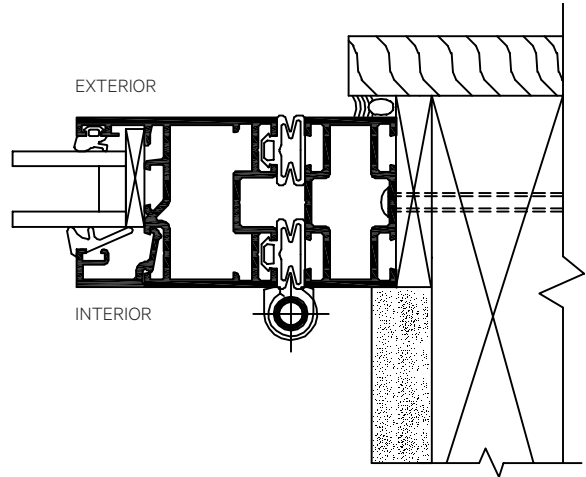

Outward Opening Panel Hinged At Right Side Jamb

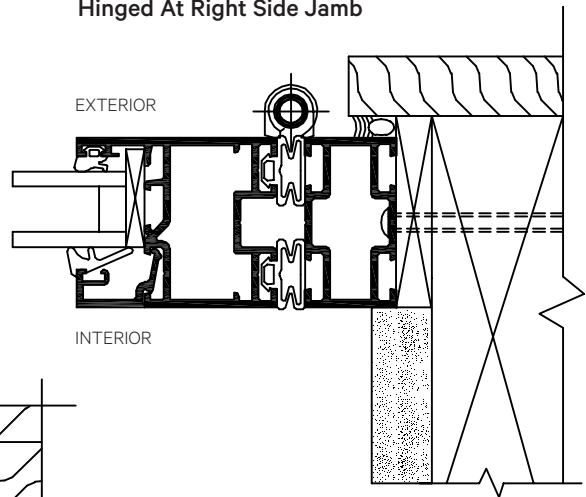

Note: For ADA compliance in commercial projects, a gasket to cover the channel in the sill at swing panels is provided.

**Flush Sill**

(No rating against wind driven rain.)

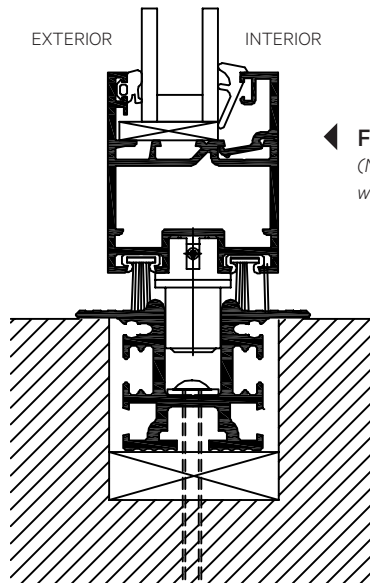

◀ **Flush Sill**  
(No rating against wind driven rain.)

**Low Profile Saddle Sill\***

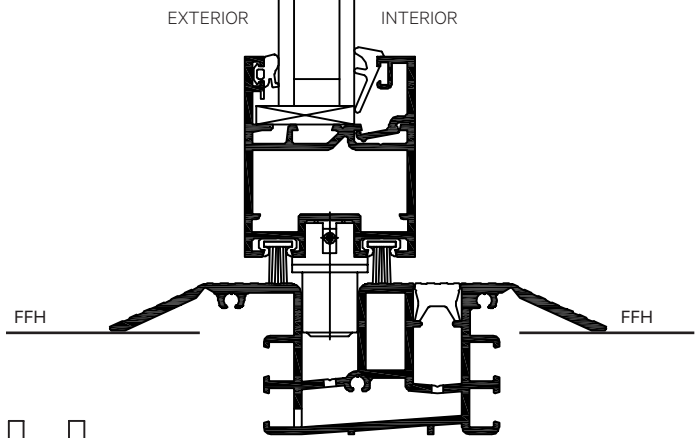

**Surface Mounted Interior Sill**

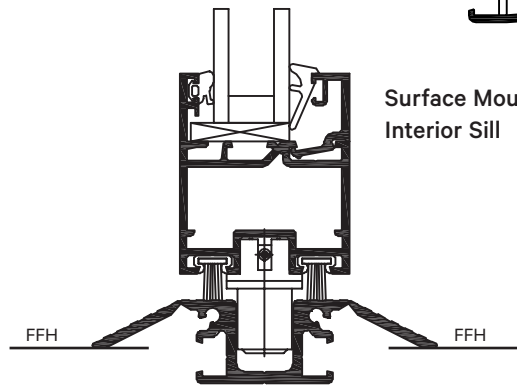

**Alternate - Standard Sill with Sub-Sill**

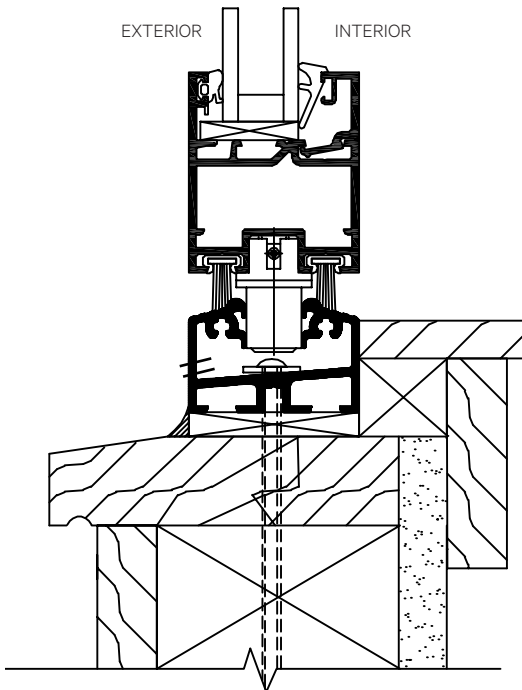

**Note:** For ADA compliance in commercial projects, a gasket to cover the channel in the sill at swing panels is provided.

**INSTALLATION NOTES**

Suggested Typical Installation drawings shown are very general and may not be suitable for any particular installation. Product placement, fasteners, flashing, waterproofing, sealant, trim, and other details for specific surrounding conditions must be properly designed and provided by others.

**Installation Considerations**

The approximate weight of a panel is 4 lbs/ft<sup>2</sup> (single glazing) and 5.5 lbs/ft<sup>2</sup> (double glazing). The vertical structural deflection of the header should be limited to the lesser of L/720 of the span and 1/4" under full loads. Structural support for lateral loads (both windload and when the panels are stacked open) must be provided. See "Pre-Installation Preparation and Installation Guidelines" in the General Introduction and "Owner's Manual" with installation instructions available for this system.

It is recommended that all building dead loads be applied to the header prior to installing the NanaWall. If so and if a reasonable amount of time has been allowed for the effect of this dead load on the header, then only the building's live load can be used to meet the above requirements of L/720 or 1/4". If not, both the dead and live loads need to be considered.

**\*FOR LOW PROFILE SADDLE SILL**

For resistance against wind driven rain, the following is recommended by others:

1. Remove the gasket covering the inner channel.
  2. Provide necessary weepholes at the bottom of the channels and on the outside face of the sill.
  3. Make necessary drain connections.
- Contact NanaWall for a detailed drawing.

Typical Kickplate

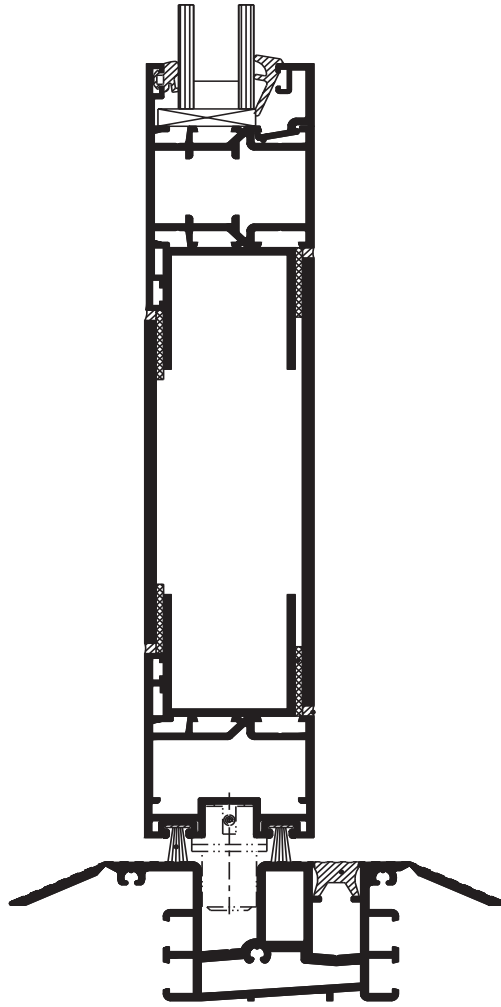

Simulated Divided Lites Muntin with Spacer Bar

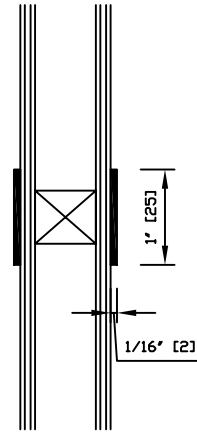

Typical Mullion Profile

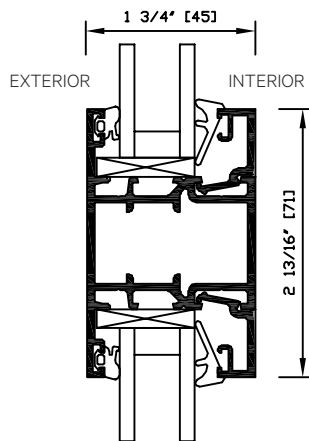

Profile with Single Glazing

